

audison



prima



AP4.9 bit

USER'S MANUAL

rev. 2.0 g



ideato,
progettato,
costruito
in Italia

Index

1. PRODUCT DESCRIPTION / PRECAUTIONS	3
2. PACKAGE CONTENTS	3
3. AP4.9 bit and DRC INSTALLATION	4
4. CONNECTION PANEL DESCRIPTION	5
1 POWER	5
2 INPUTS / REM IN-OUT	6
3 ASP AUTOMATIC SPEAKER PRESENCE	7
4 SPEAKER OUT	7
5 SUB OUT	8
6 OPTICAL IN	8
7 DSP OUT	8
8 DRC	9
9 USB	10
10 UPGRADE OFF-ON	10
11 PRESET	10
12 FUSE	10
13 LOGO STATUS	10
5. CONNECTIONS	11
5.1 POWER SUPPLY AND REMOTE TURN ON	11
5.2 INPUT SIGNALS	12
5.3 DIGITAL OPTICAL IN INPUT SIGNALS	13
5.4 OUTPUT SIGNALS	14
5.4.1 PRESET 0: DEFAULT: 2 WAY ACTIVE FRONT + EXTERNAL SUBWOOFER	15
5.4.2 PRESET 1: FRONT + REAR + EXTERNAL SUBWOOFER	16
5.4.3 PRESET 2: FRONT + BRIDGE SUBWOOFER	17
5.4.4 PRESET 3: HI POWER FRONT + EXTERNAL SUBWOOFER	18
5.4.5 PRESET 4: 3 WAY ACTIVE FRONT + SUB	19
5.4.6 PRESET 5: 3 WAY ACTIVE FRONT + REAR + SUBWOOFER	20
5.4.7 PRESET 6: 2 WAY ACTIVE FRONT + REAR + SUBWOOFER	21
5.4.8 PRESET 7: 2 WAY ACTIVE FRONT + REAR + 2 WAY ACTIVE CENTER + SUBWOOFER	22
5.5 PERSONAL COMPUTER E CONTROLLO REMOTO DIGITALE (DRC)	23
6. GUIDE FOR INSTALLING/UNINSTALLING PRIMA SOFTWARE AND DRIVERS	24
6.1 GUIDED PROCEDURE FOR PC SOFTWARE INSTALLATION	24
6.2 GUIDED PROCEDURE FOR DRIVER INSTALLATION	26
6.3 UNINSTALLING AP4.9 bit SOFTWARE	27
7. HOW TO SET UP AP 8.9 BIT WITH A PC AP4.9 bit WITH A PC	28
7.1 OFFLINE MODE	28
7.2 TARGET MODE	29
7.3 ADJUSTING ACOUSTIC REPRODUCTION	35
7.3.1 DEVICE INFO	35
7.3.2 FILE MAIN MENU	36
7.3.3 MEMORIES MAIN MENU	36
7.3.4 SETTINGS MAIN MENU	37
7.3.5 DEVICE MAIN MENU	40
7.3.6 HELP MAIN MENU	41
7.3.7 SELECTED INPUT	41
7.3.8 CHANNEL MAP	41
7.3.9 SELECT CHANNEL	42
7.3.10 FILTER SETTINGS	42
7.3.11 SET DISTANCE AND DELAY	44
7.3.12 PARAMETRIC EQUALIZER	47
7.3.13 OUTPUT LEVEL	48
7.3.14 MEMORY	48
7.3.15 STATUS BAR	48
8. TROUBLESHOOTING	49
8.1 SYNCHRONIZATION WITH A PC	49
8.2 BACKGROUND NOISE	49
8.3 FIRMWARE UPGRADE	49
9. DRC - DIGITAL REMOTE CONTROL (OPTIONAL)	52
9.1 SEL BUTTON FUNCTIONS	53
9.2 OPERATIONAL ERROR MESSAGES	53
10. ACCESSORIES	54
10.1 ASP - AUTOMATIC SPEAKER PRESENCE	54
10.2 ACP2 - 2 RCA ADAPTER CABLE	54
10.3 ACP6 - 6 RCA ADAPTER CABLE	54
10.4 APL 2 - AP4 D / AP1 D LINK CABLE	54
10.5 APK 3 - AUDISON PRIMA TOWER KIT 3	55
10.6 DRC DIGITAL REMOTE CONTROL	55
10.7 ECK DRC - CABLE EXTENSION KIT	55
10.8 OP 1.5 TOSLINK OPTICAL CABLE 1,5 m / 59.05 in.	55
10.9 OP 4.5 TOSLINK OPTICAL CABLE 4,5 m / 177.16 in.	56
10.10 STA - F/F SOCKET TOSLINK ADAPTER	56
10.11 SFC SAMPLING FREQUENCY CONVERTER	56
11. TECHNICAL SPECIFICATIONS	57

1. PRODUCT DESCRIPTION / PRECAUTIONS

AP4.9 bit is an amplifier featuring 4 channels settable into bridge mode, with a 32-bit, 147-MHz digital signal processor (DSP) and 24-bit Analog-Digital and Digital-Analog converters, essential to optimize the acoustic performance of your Car Audio entertainment system. It connects to any OEM system, even in vehicles with built-in audio processor, since the **AP4.9 bit** sends back a linear signal thanks to the De-Equalization function.

It features 7 signal inputs, 6 Hi-Level and 1 S/PDIF optical digital, and provides 4 amplified outputs and 5 booster outputs for an analog amplifier, to offer a 9-channel amplified system.







Each output channel features: a graphically adjustable parametric equalizer group, a 68-step frequency electronic crossover as well as BUTTERWORTH or LINKWITZ filters with 6-24 dB slopes and a digital time delay line.

The user can adjust the **AP4.9 bit** settings through the DRC remote control device.

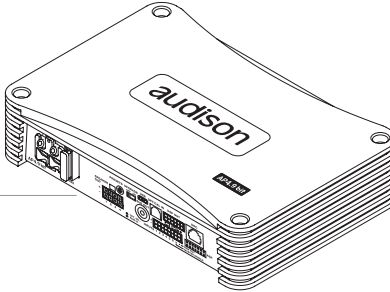
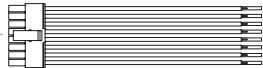
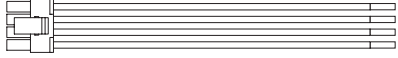
- WARNING:** 1. a PC provided with Windows XP, Windows Vista, Windows 7 or Windows 8 operating system, 1.5 GHz minimum processor speed, 1 GB RAM minimum memory and a 1024 x 600 pixels minimum resolution graphics card as well as at least 512 MB of available hard-disk space are required to install the software and setup the product.
2. Before connecting the product, carefully read this manual. Improper connections may cause damage to **AP4.9 bit** or to the speakers in your car audio system.

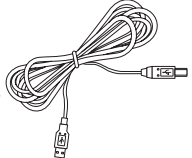
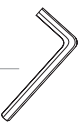
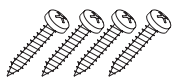

2. PACKAGE CONTENTS

- **AP4.9 bit amplifier** 
- Multipolar cable, Inputs/Rem: 
- Multipolar cable, Speakers out: 
- Multipolar cable, DSP out: 
- NR. 1 - 30A replacement fuse: 
- 1.8 m USB cable: 
- 2.5 mm hex key: 
- NR. 4 - 4.2 x 50 mm self-tapping, cross head mounting screws: 
- CD ROM containing:
AP4.9 bit Software
 This owner's manual (.pdf)
 Audio Test Tracks 
- Quick start guide 
- Warranty 

3. AP4.9 bit AND DRC INSTALLATION

External Size

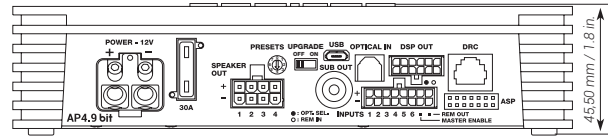
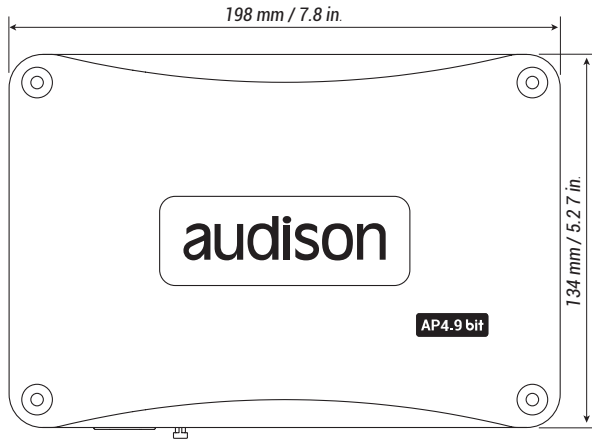

Mounting Size

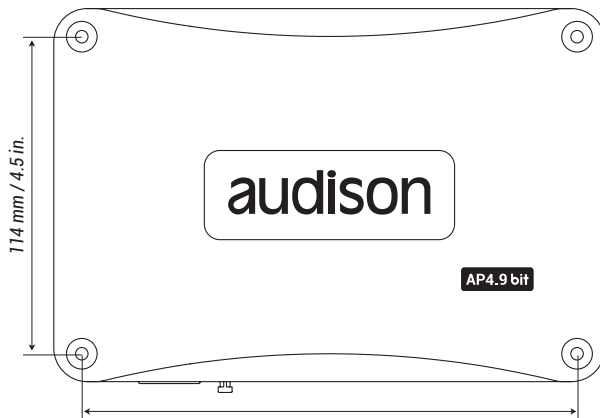

How to mount

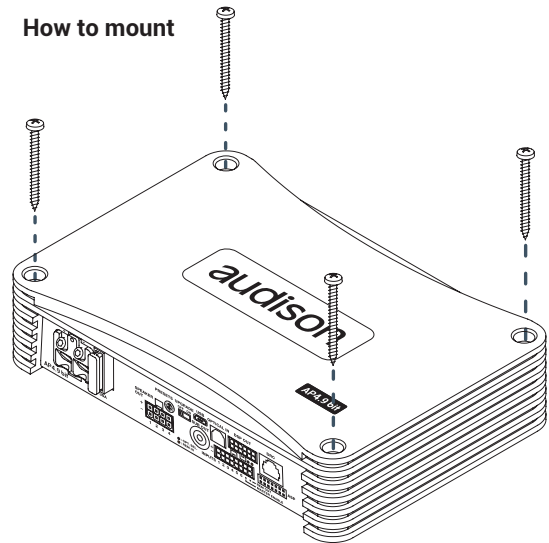

DRC (optional) Installation

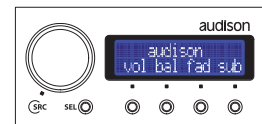
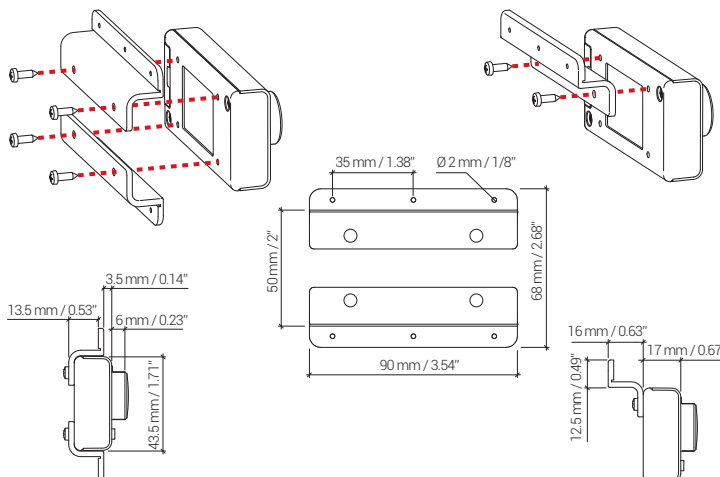

Important: Do not use aggressive cleaning agents or abrasive cloths to clean the display. Simply use a soft cotton cloth that has been lightly dampened with water.

4. CONNECTION PANELS - DESCRIPTION

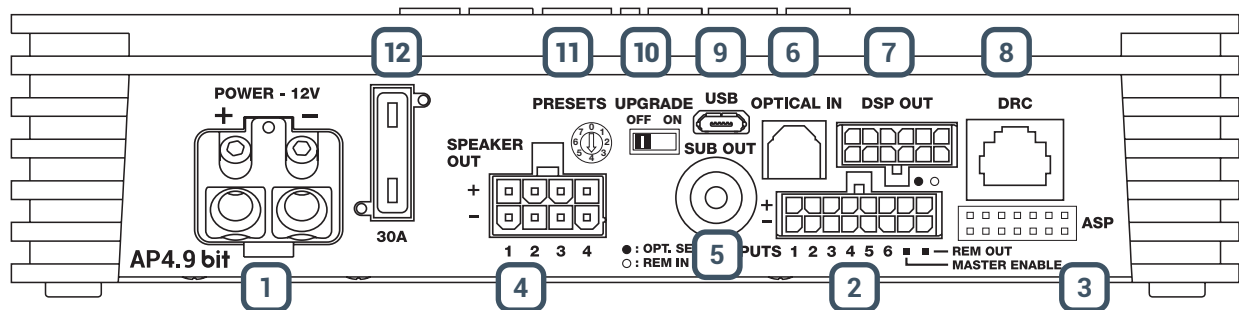
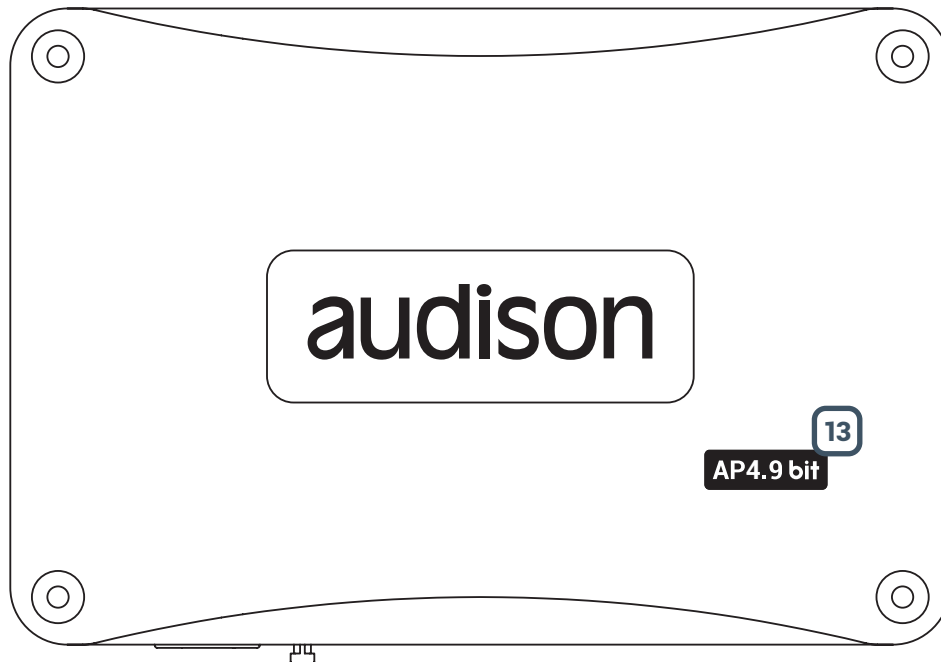

1 POWER.

+Power (11-15 VDC): connection terminal for **AP4.9 bit** power supply positive pole. The jack accepts a stripped cable up to 15mm/0.6" with maximum section of 8 AWG (\varnothing 3,2mm / 0.12"). For better power transfer we recommend using cables with the largest possible cross-section and with the same cross-section as the cable connected to the negative pole.

- Power (Ground): connection terminal for the negative power supply pole of the amplifier. Connect here the negative battery cable or a cable connected to the vehicle chassis. The opening will take a stripped cable up to 15mm/0.6" with a maximum section of 8 AWG (\varnothing 3,2mm / 0.12"). For better power transfer, we recommend using cables with the largest possible section and with the same section as the cable connected to the positive pole. In order to correctly connect the ground (-), use a screw that is already present on the metal part of the vehicle; If necessary, remove any paint residue or grease, using a tester to make sure there is continuity between the negative terminal (-) on the battery and the mounting point. If possible, connect all of the grounds on the audio components to the same grounding point. This helps reduce most of the interference than can occur in audio reproduction.

WARNING: Make sure the connection polarity is as indicated on the terminals. A misconnection may result in damage to the AP4.9 bit. After applying power, wait at least 10 seconds before turning the AP4.9 bit on.



2 INPUTS / REM IN-OUT.

AP4.9 bit comes with a 16 pole multipolar connector to manage the input signals, REM IN/REM OUT connections and the control functions for the auxiliary inputs.

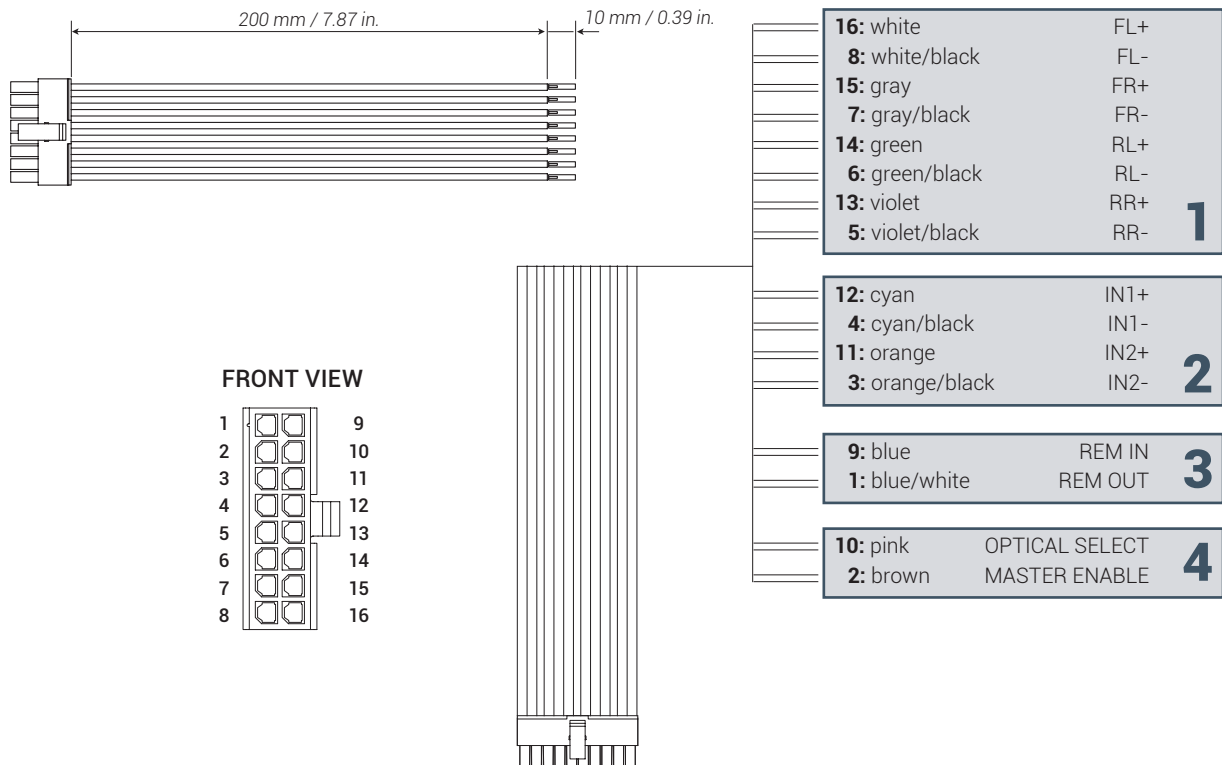

1. INPUTS FL FR RL RR: MASTER inputs connect here the amplified signal wires coming from the main analog source. Input sensitivity automatically adjustable from 2 to 15 V RMS (see sec. 7.2.5). Channels **FL FR RL RR** feature the AUTO TURN ON (ART) function through connection with the outputs on the source speakers. This function can be excluded using the PC Software.

Remark: The ACP6 / ACP2 accessory can also be used to interface head units equipped with PRE OUT output (min. 2V) to the **AP4.9 bit** inputs. (see sec. 10.2 - 10.3)

2. INPUTS IN1 IN2: Auxiliary signal inputs that can be used when configuring the unit to reconstruct a multi-amplified signal (Front Tweeter, Front Mid Hi, Center, Sub) or specialized like AUX inputs (see sec. 7.2.5).

3. REMOTE:

- **REM IN.** Input to turn on **AP4.9 bit** remotely through the audio signal source Remote Out. REM IN can be connected to the ignition switch terminal (ACC). The voltage must be between 7 and 14.5 VDC. If using a source with a amplified outputs, **AP4.9 bit** can be automatically turned on (see sec. 7.3.4.7), so it will not be necessary to connect the REM IN terminal.
- **REM OUT.** Output to turn on other devices/amplifiers connected after **AP4.9 bit**. From the time it is turned on, it takes 1 second to supply the signal to the REM OUT output, but it will be possible to set this delay via software (see sec. 7.3.4.7). The 200 mA output current capability can also drive an automotive relay.

4. SWITCH INPUTS:

- **OPTICAL SELECT:** It allows the input selection **OPTICAL IN / AUX IN**. This control is active bringing the terminal to +12V and the input choice to be activated can be programmed using the PC software (see sec. 7.3.4.7), the unit can also be turned on using this terminal.
- **MASTER ENABLE:** It enables the **MASTER** input selection. This control is active bringing the terminal to +12V.

3 ASP AUTOMATIC SPEAKER PRESENCE

Input for ASP module if using signals coming from OEM sources. This module simulates the load of the OEM factory system speakers, allowing proper interface allowing proper interfacing between the source amplified outputs and the **AP4.9 bit** analog inputs. (see sec. 7.3.4)

The ASP module is optional and is required only in some cases when installing with factory OEM sources.

WARNING: If interfacing AP4.9 bit with sources equipped with PRE OUT outputs, this module must not be used.

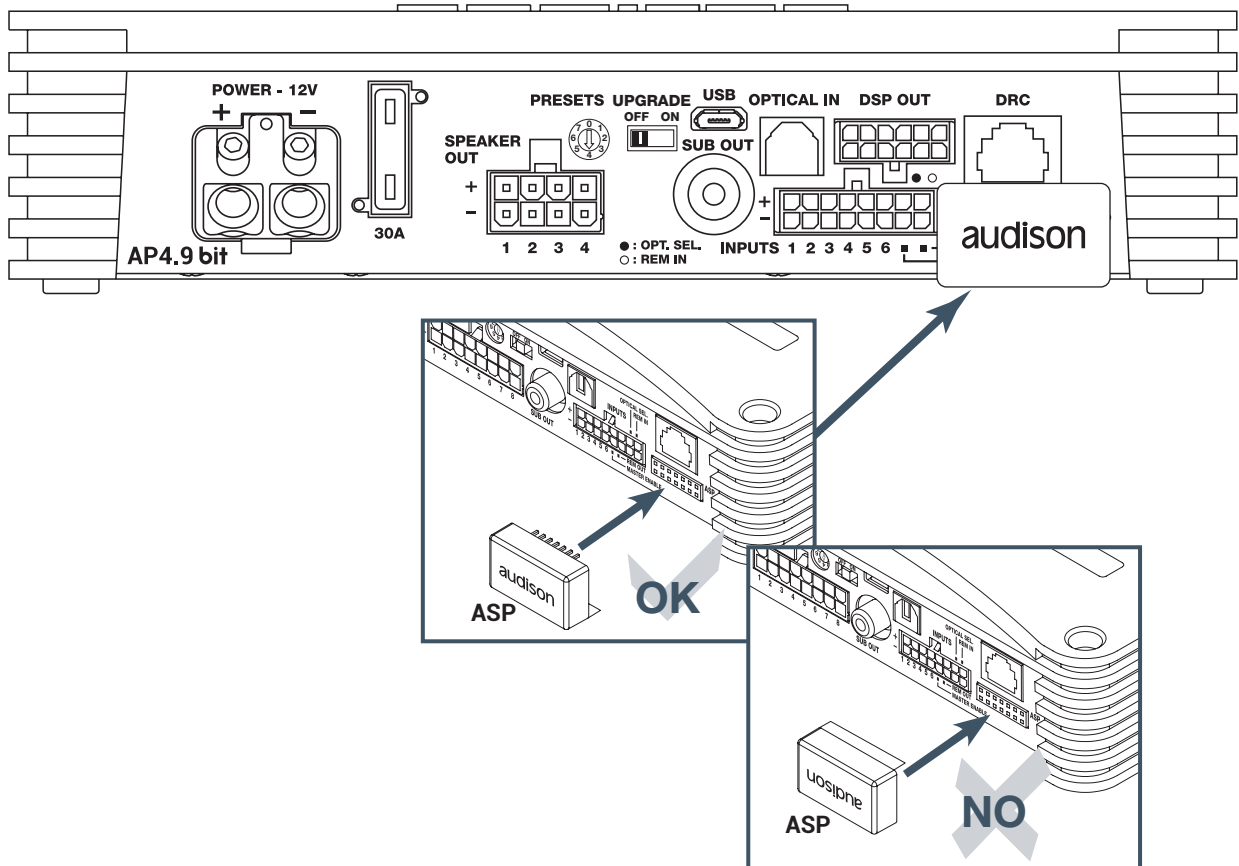

4 SPEAKER OUT.

AP4.9 bit comes with a 8 pole multipolar connector to manage the 4 power output channels.

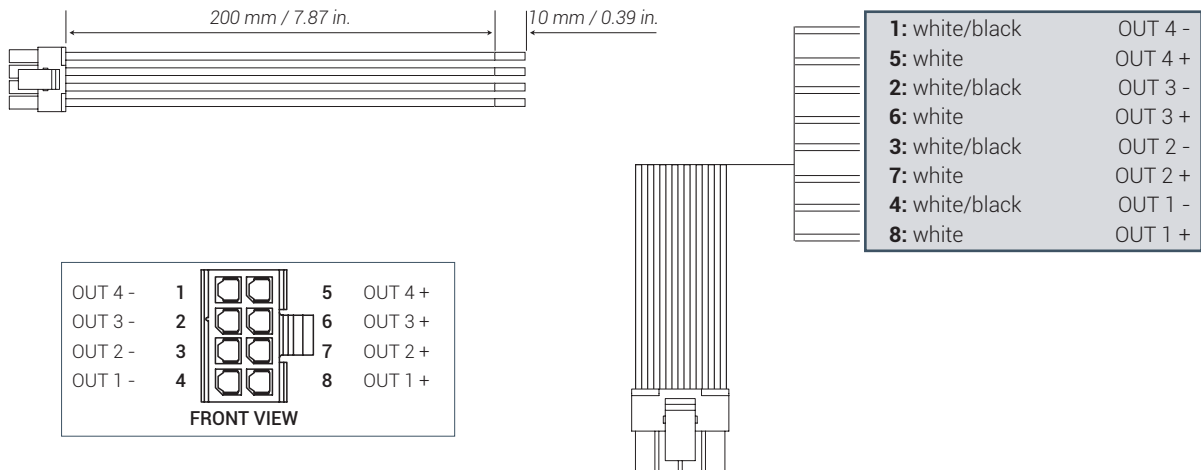

5 SUB OUT.

LO PASS filtered pre-amplified output optimized to drive a mono amplifier for an external or active subwoofer. (see sec. 5.4)

6 OPTICAL IN.

AP4.9 bit accepts at its input PCM signals up to 96 kHz / 24 bit sampling frequency rate. So DOLBY DIGITAL (AC3) multi-channel signals coming from audio/video sources (such as the audio of a film in DVD) or DTS can not be reproduced. Connect a fiber optic cable with a TOSLINK connector. This input can be selected using the external DRC control or by activating it using the **OPTICAL IN** terminal. (see sec. 5.2)

7 DSP OUT.

The AP4.9 bit comes with a 12-pin connector to link 4 analog signals in the DSP to an Audison AP4 D amplifier or any 4-channel amplifier (see example 2). The standard product comes with a cable that can be connected to the AP4 D standard input cable by linking the relays to the inputs, respecting the colors indicated (see example 1). If you are not using an AP amplifier this cable can be re-headed with RCA connectors which might be connected to the amplifier used (example 2). It is also possible to use a TLC.AP4-1 accessory cable to directly connect the AP4.9 bit to an AP4 D amp (example 3).

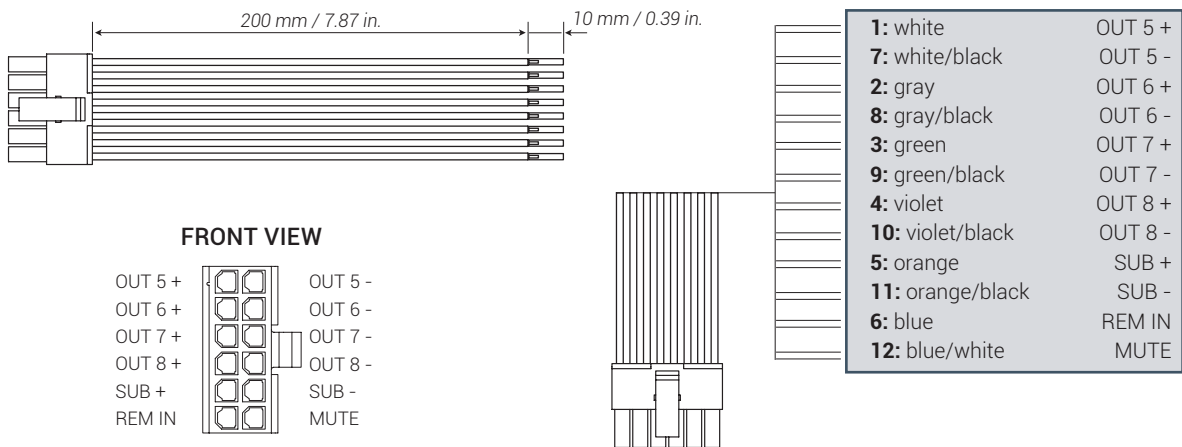

EXAMPLES:

1. Audison AP4.9 bit + Audison AP4 D

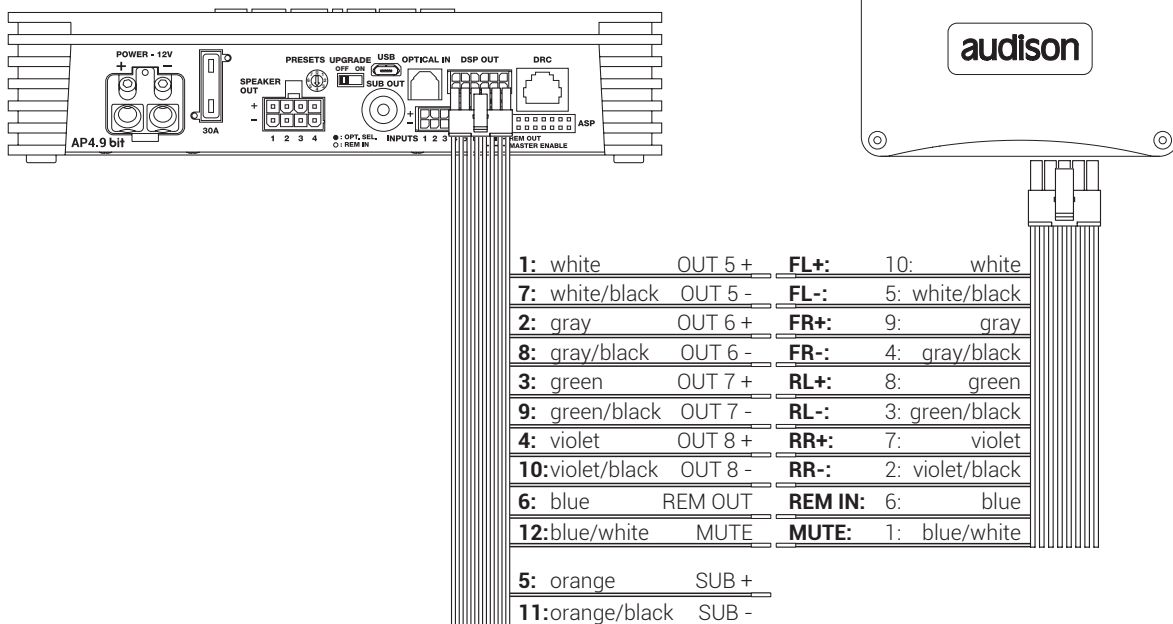

2. Audison AP4.9 bit + 5 channel Amplifier

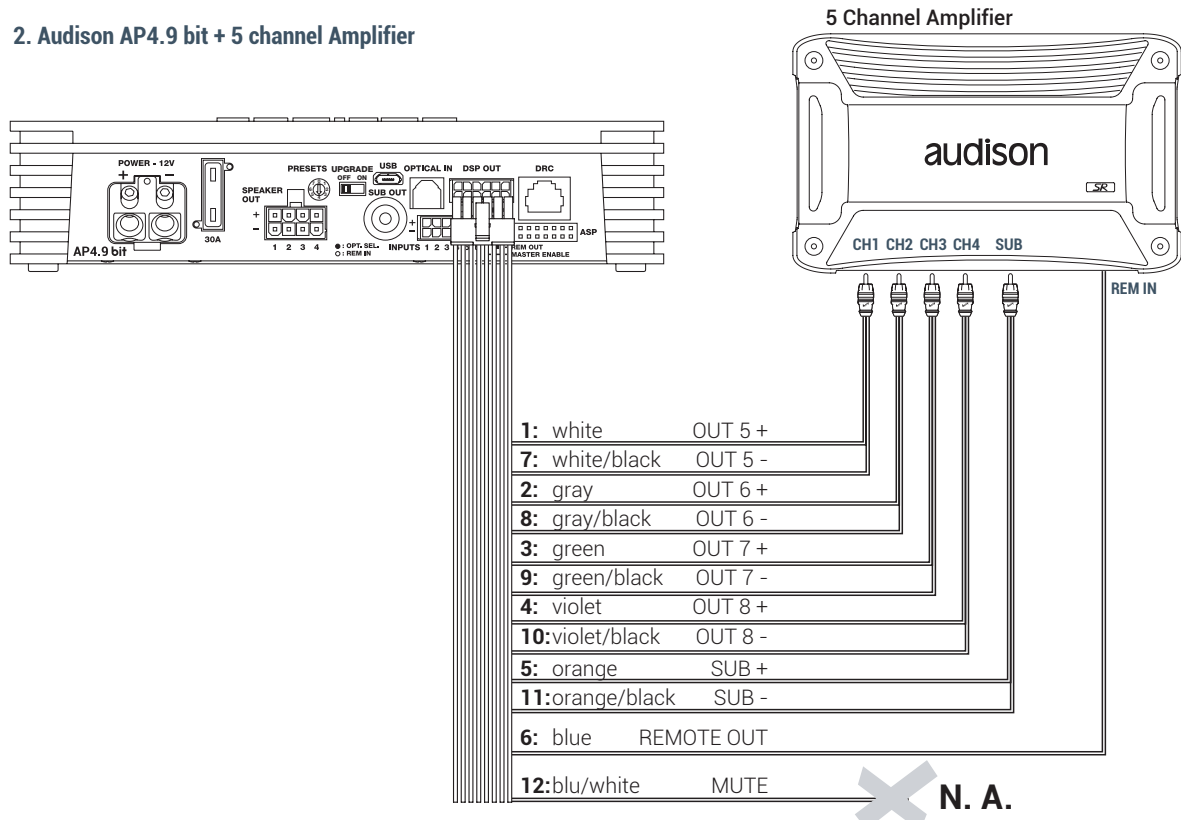

3. Audison AP4.9 bit + Audison AP4 D + AP1 D with connection through APL 2 (optional)

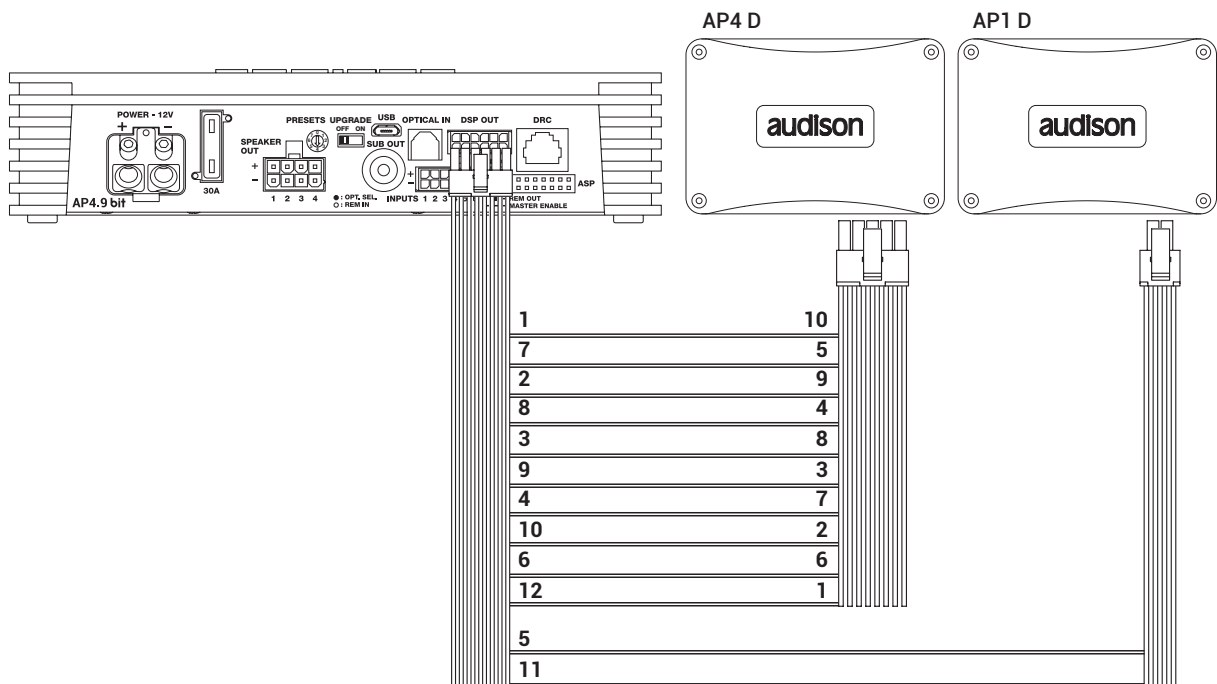

8 DRC.

Connection terminal for remote control of the functions (OPTIONAL) on **AP4.9 bit**. (see sec. 5.5 - sec. 9).

9 USB.

USB (micro) connection to connect the product to a PC in order to manage the functions using **AP4.9 bit** software. The connection is USB 1.1/2.0/3.0 compatible.

10 UPGRADE OFF-ON.

Switch ON allows the product to be updated in BOOT LOADER mode. ([see sec. 8.3](#))

11 PRESET.

AP4.9 bit has 8 setups preloaded in its memory, one being editable. They allow the product to be used without the need to connect it to a PC. ([see sec. 5.4.1; 5.4.8](#))
The preset choice is based on the factory system in the car or the type of system you wish to create.

12 FUSE.

30 A blade protection fuse needs to be replaced, use same type and value as the original.

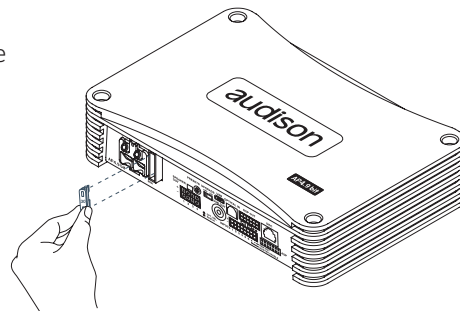

13 LOGO STATUS.

AP4.9 bit has an built-in control that manages its status and protects the circuits and connections to the speakers. The logo on the **AP4.9 bit** top cover will change its status in case of any possible product malfunctions.

A BLUE logo means:

AP4.9 bit is on.

A flashing RED/BLUE logo means:

The **"UPGRADE MODE"** switch on the product is set to **"ON"** position, or the product Firmware is being updated.

A flashing BLUE logo means:

The unit is in stand-by (energy saver) because there is no audio signal. This function (**AST**) can be activated using the PC software. ([see sec. 7.3.4.7](#)) and the stand-by time ranges from a minimum of 5 mins. to a maximum of 20 mins. The unit will automatically turn off after 30 mins. when there is no signal.

A RED logo flashing one single time every 2 seconds means:

- **AP4.9 bit** temperature reached 75° C and the thermal protection was triggered. It will start operating again at around 70° C.

A RED logo flashing twice every second means:

- Output overload. The red LED flashes when the output load goes below the minimum allowed capacity of about 2Ω impedance. The LED comes on without flashing, activating the protection. When listening to music, if the acoustic reproduction stops for a few seconds, check if the red amplifier LED is flashing. This means there was an overload. Turn the amplifier off and check the speakers and wirings.
- Speaker wiring anomaly. The red LED flashes when a terminal on the speaker goes in short-circuit with the vehicle chassis. When listening to music, if the acoustic reproduction stops for a few seconds, check to see if the red amplifier LED is flashing; this means there was a short circuit between a terminal on a speaker and the vehicle chassis. Turn off the amplifier and check the speakers and wiring.

A RED logo flashing four times every second means:

- The **"OVER VOLTAGE"** protection activation, due to the fact that the battery voltage is higher than 16V. The product will turn off after 3 minutes.

WARNING: Check the state of charge of the car alternator.



A RED logo means:

- Product internal fault. You have to go to an authorized service centre. The product will turn off after 3 minutes.

5. CONNECTIONS

5.1 POWER SUPPLY AND REMOTE TURN ON

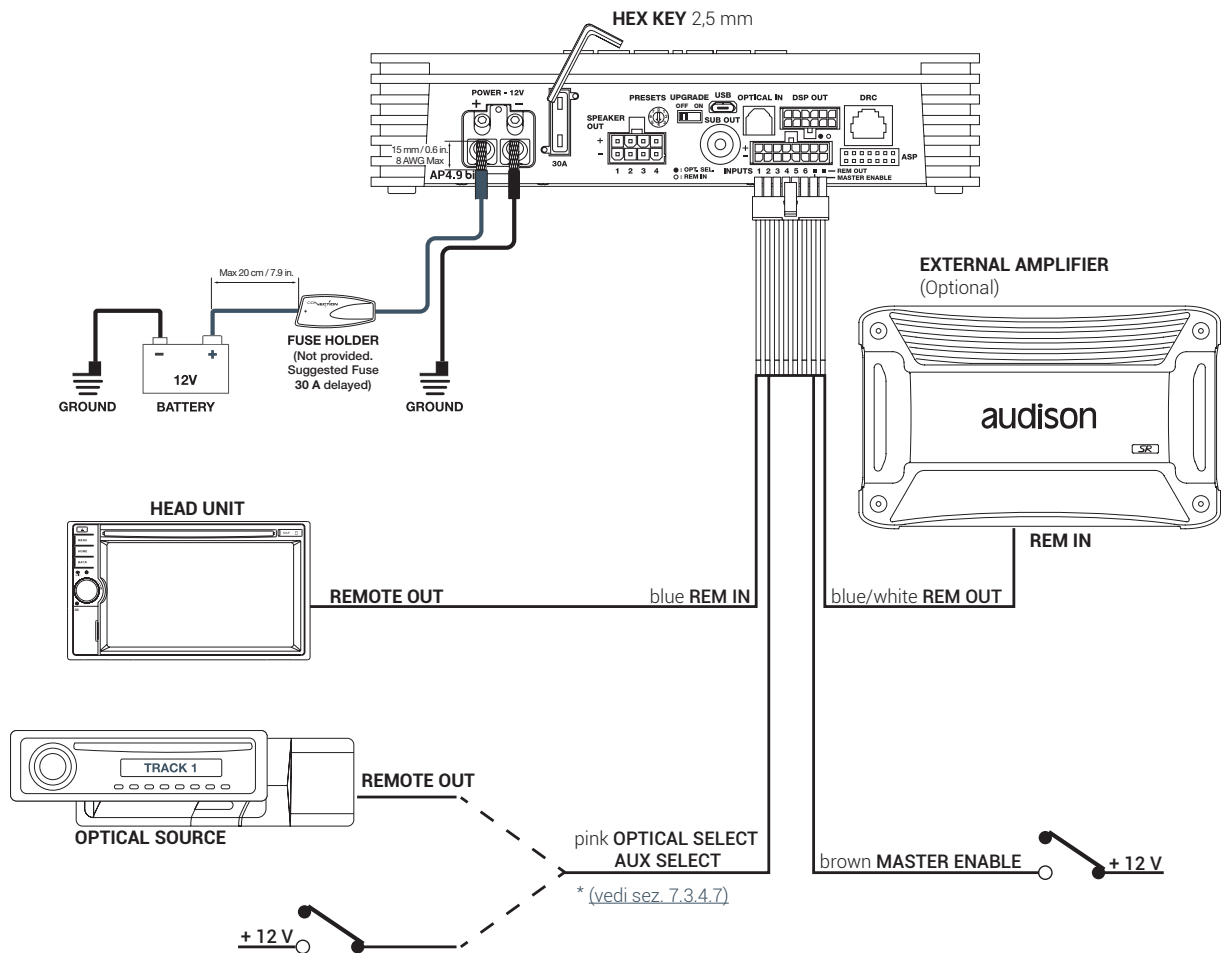

Turn AP4.9 bit on and off

AP4.9 bit is on when the logo is lit blue. It can be turned on/off using the following methods:

1. By pressing on the main DRC control knob (ON). By holding down the main control knob on the DRC (OFF). In this case, no other Remote In connections are needed, but they can co-exist.
2. By connecting the REMOTE IN terminal with a Remote Out signal coming from an after market audio source.
3. Through the Hi Level MASTER (FL - FR) input. The AUTO TURN ON (ART) function is activated by connecting the output of an amplified source to the INPUT FL - FR input channel. This function can be enabled/disabled using **AP4.9 bit** PC software (see sec. 7.3.4.7).
4. Using the Low Level (Pre Out) input. The AUTO TURN ON (AST) function is activated by connected the outputs on a preamplified source to the input channels to the **AP4.9 bit** input channels. This function can be enabled/disabled using **AP4.9 bit** PC Software. This turn on control is available on the FL FR RL RR IN1 IN2 inputs (see sec. 7.3.4.7).
5. By connecting the OPTICAL SELECT / AUX IN SELECT terminal with a Remote Out signal coming from an auxiliary source, or connecting to terminal to 12V. This function can be enabled/disabled using **AP4.9 bit** PC Software (see sec. 7.3.4.7).

5.2 INPUT SIGNALS

1. SPEAKER IN HI-LEVEL FRONT + REAR

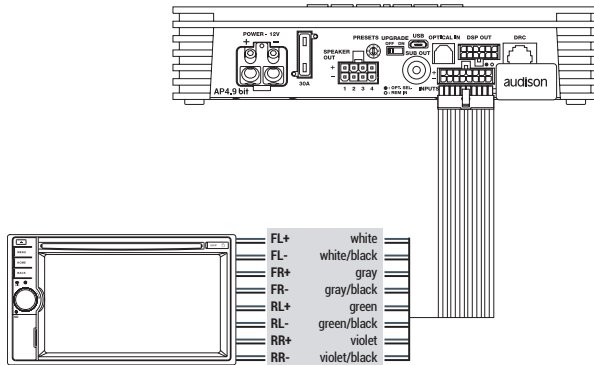

2. SPEAKER IN HI-LEVEL FRONT WOOFER + FRONT TW + REAR

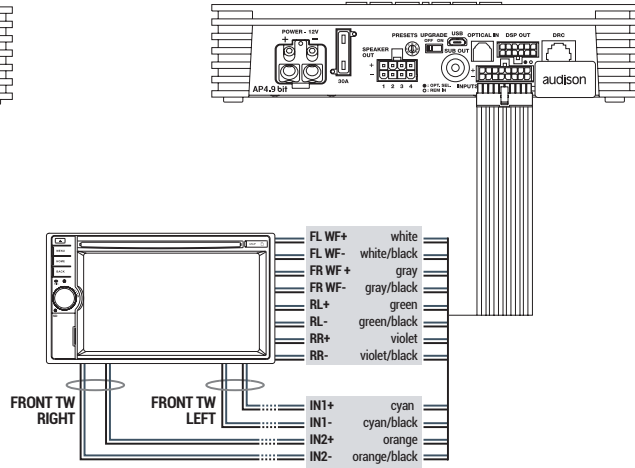

3. SPEAKER IN HI-LEVEL FRONT + REAR + CENTER + SUB

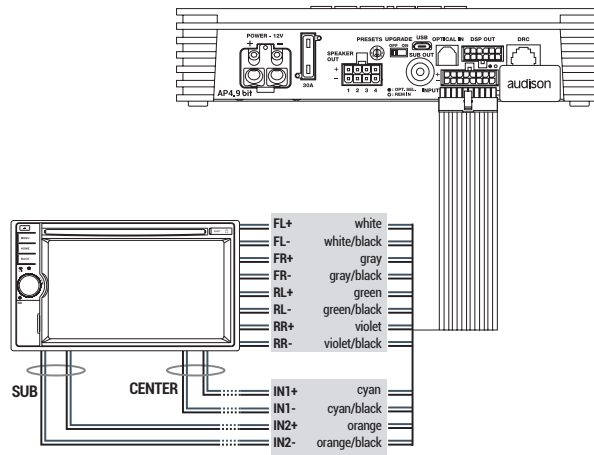

4. SPEAKER IN HI-LEVEL FRONT + REAR + LEFT SUB + RIGHT SUB

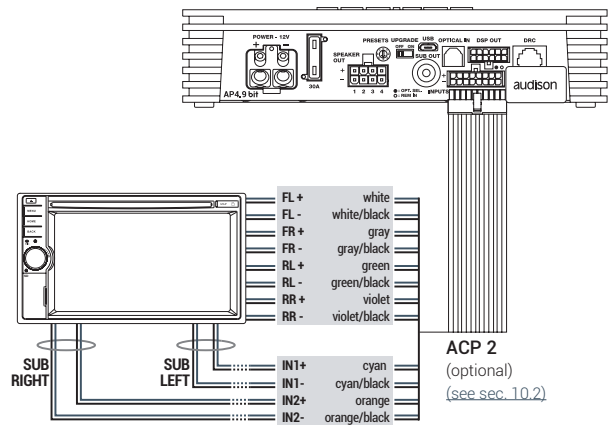

5. MASTER PRE IN FRONT + REAR + CENTER + SUB + REAR

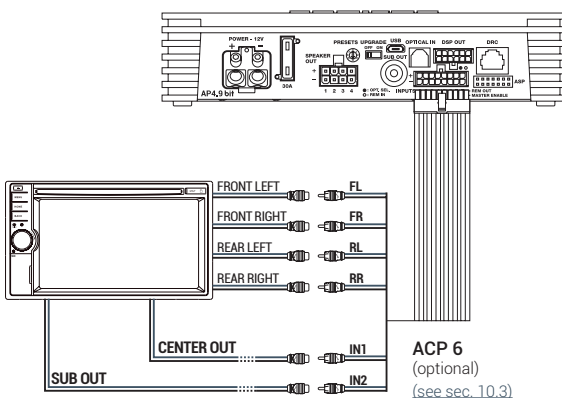

6. MASTER PRE IN FRONT + REAR

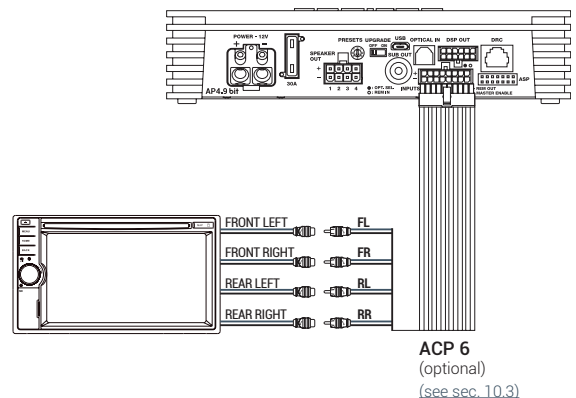

7. MASTER PRE IN FRONT + REAR + AUXILIARY STEREO SOURCE

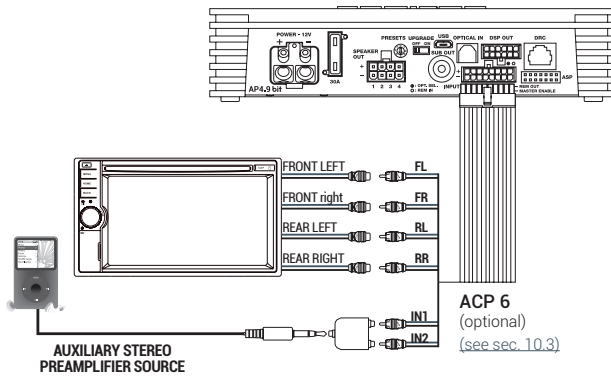

8. AUX IN L/R

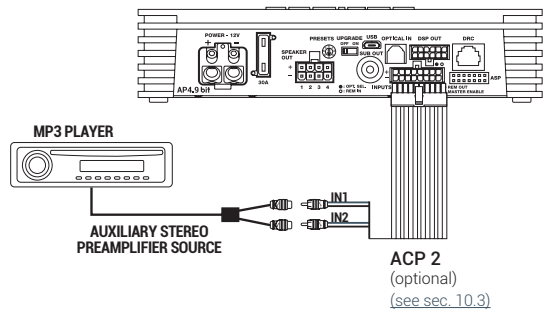
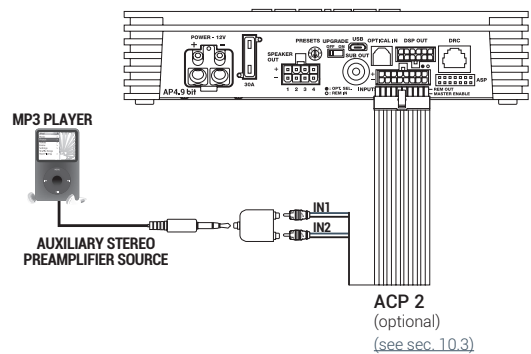

5.3 DIGITAL OPTICAL IN INPUT SIGNALS

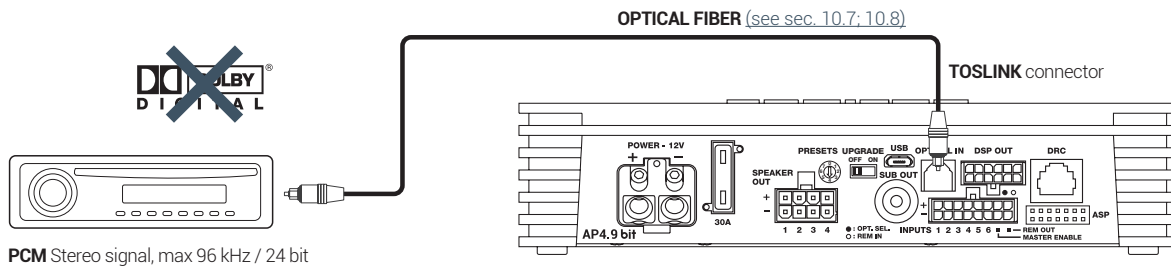

WARNING: The digital inputs accepts up to 96 kHz / 24 bit stereo PCM signals. So DOLBY DIGITAL (AC3) multi-channel signals coming from audio/video sources (such as the audio of a film in DVD) or DTS can not be reproduced. The output of these devices will therefore have to be set in STEREO mode for the signal to be reproduced. If digital signals at frequency higher than 96kHz (Ex. 192 kHz) are supplied, the **AP4.9 bit** will not be able to reproduce them.

How to select OPTICAL input:

1. Using the DRC, selecting the **OPTICAL** input.
2. Using the appropriately set **OPTICAL IN** terminal (see sec. 7.3.4.7).
This command is active connecting the terminal to + 12V.

5.4 OUTPUT SIGNALS

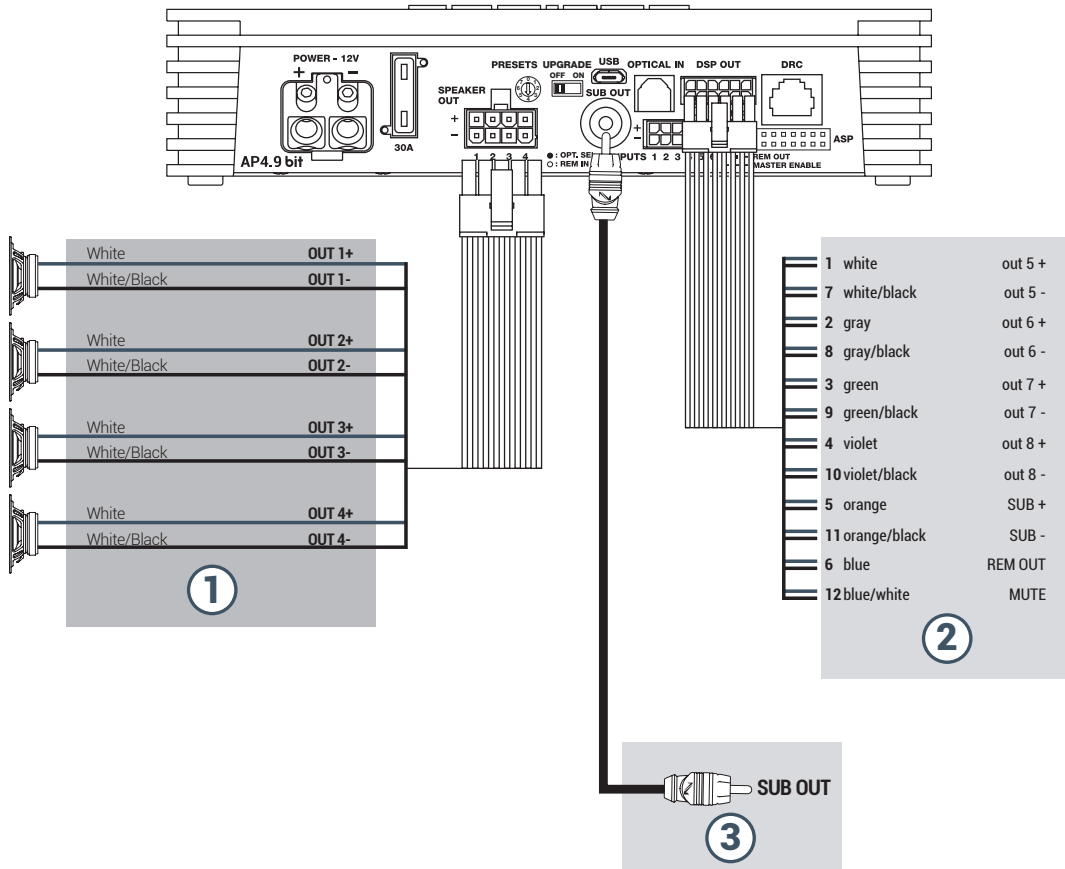

1. L'AP4.9 bit The AP4.9 bit provides 4 amplified outputs. Each output channel is configured through PC software (see section 7.2):

- A 10-pole parametric equalizer;
- A 68-frequency electronic crossover and Butterworth or Linkwitz-Riley filters with 6-24 dB slopes (see section 7.3.10);
- A digital time delay line (see section 7.3.11);
- Phase inversion (see section 7.3.10.2);
- Output level adjustment to better align the total response of the system (see section 7.3.13);

CONFIGURAZIONE CANALI D'USCITA AMPLIFICATI CH1÷CH4

POWER CHANNEL CONFIG	
STEREO MODE	
CH1	70 W @ 4 Ohm / 130 W @ 2 Ohm
CH2	70 W @ 4 Ohm / 130 W @ 2 Ohm
CH3	70 W @ 4 Ohm / 130 W @ 2 Ohm
CH4	70 W @ 4 Ohm / 130 W @ 2 Ohm
BRIDGE MODE	
CH1+ 2-	260 W @ 4 Ohm
CH3+ 4-	260 W @ 4 Ohm

2. The AP4.9 bit features a 12-pin DSP OUT connector to relay 5 additional channels internal to the DSP and managed by PC software. It is possible to connect an AP4 D / AP1 D amplifier or a generic amplifier to this socket through an adapter cable. For connections see section 4.5.

3. AP4.9 bit features one DSP OUT preamplified output (4 V Rms max.) that exclusively controls a mono amplifier for subwoofer, or one active subwoofer to amplify the sound system. This output can be activated during the I/O Wizard Configuration (see sec. 7.2.9).

5.4.1 PRESET 0 DEFAULT: 2 WAY ACTIVE FRONT + EXTERNAL SUBWOOFER

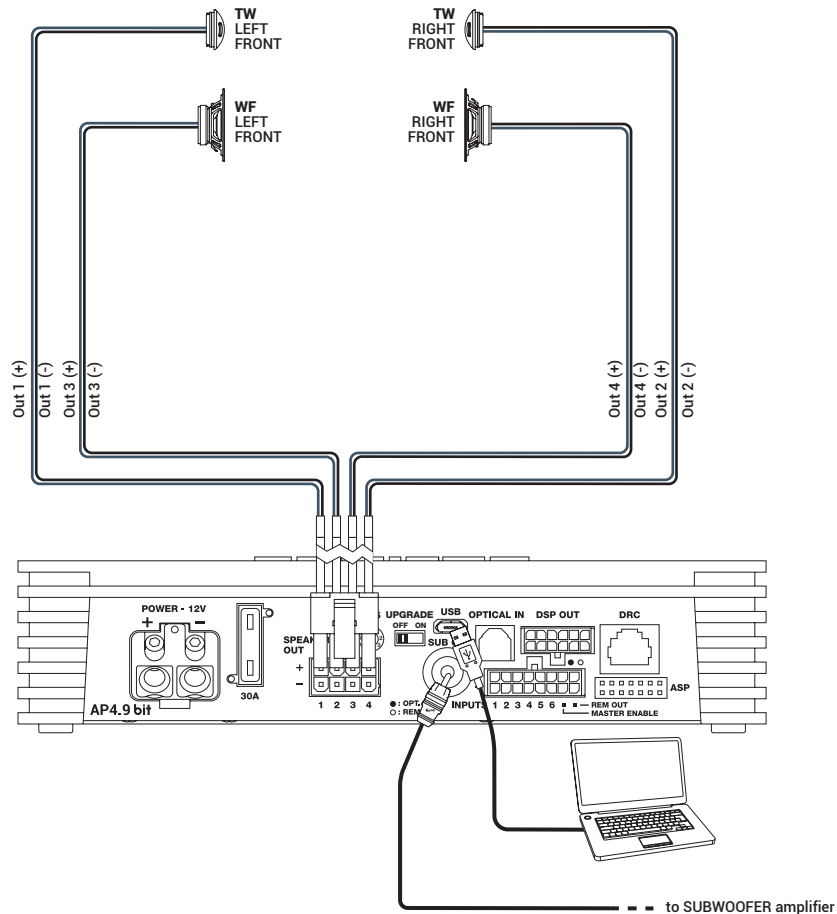
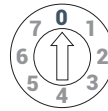

INPUT CONFIGURATION:

Master input: Front + Rear

Aux input: In1 + In 2

Optical: S/P-DIF PCM 96kHz/24 bit max

OUTPUT CONFIGURATION:

OUTPUT	TYPE	CUT FILTER	FILTER TYPE	CUT FREQUENCY	TIME ALIGNMENT*	POWER @ 4Ω	POWER @ 2Ω
OUT 1	FRONT TW LEFT	HI PASS	Linkwitz	3000 Hz @12 dB	0 cm	70 W	130 W
OUT 2	FRONT TW RIGHT	HI PASS	Linkwitz	3000 Hz @12 dB	0 cm	70 W	130 W
OUT 3	FRONT WF LEFT	BAND PASS	Linkwitz	80 Hz @12 dB 3000 HZ @ 12 dB	0 cm	70 W	130 W
OUT 4	FRONT WF RIGHT	BAND PASS	Linkwitz	80 Hz @12 dB 3000 HZ @ 12 dB	0 cm	70 W	130 W
PRE OUT	SUB WOOFER	LO PASS	Linkwitz	80 Hz @12 dB	0 cm	-	-

■ = Max power suggested Loads: 280 W + SUBWOOFER

MEMORY CONFIGURATION:

Memory A: Acoustic

Memory B: Rhythm

***Listening Point:** Driver

5.4.2 PRESET 1: FRONT + REAR + EXTERNAL SUBWOOFER

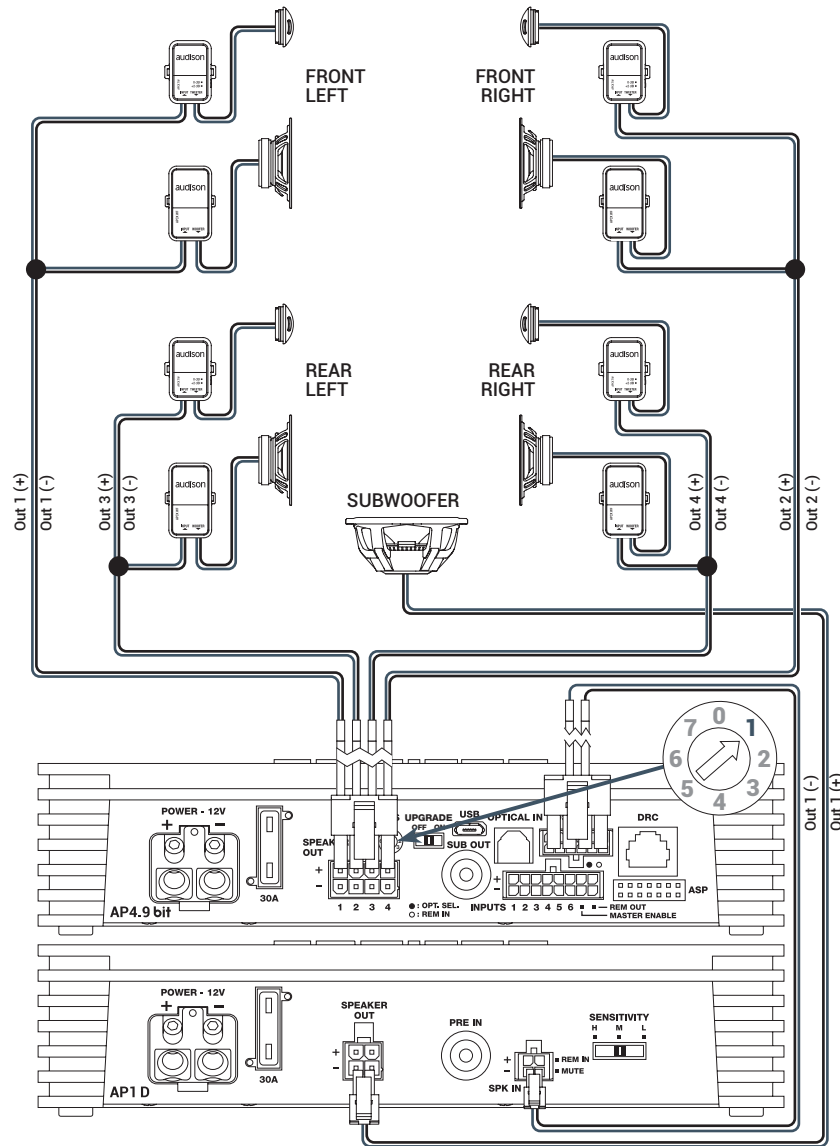
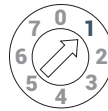

INPUT CONFIGURATION:

Master input: Front + Rear

Aux input: In1 + In 2

Optical: S/P-DIF PCM 96kHz/24 bit max

OUTPUT CONFIGURATION:

AP TYPE	OUTPUT	TYPE	CUT FILTER	FILTER TYPE	CUT FREQUENCY	TIME ALIGNMENT*	POWER @ 4Ω	POWER @ 2Ω
4.9 bit	OUT 1	FRONT FULL LEFT	HI PASS	Linkwitz	80 Hz @12 dB	82,2 cm	70 W	130 W
4.9 bit	OUT 2	FRONT FULL RIGHT	HI PASS	Linkwitz	80 Hz @12 dB	116,2 cm	70 W	130 W
4.9 bit	OUT 3	REAR FULL LEFT	HI PASS	Linkwitz	80 Hz @12 dB	82,2 cm	70 W	130 W
4.9 bit	OUT 4	REAR FULL RIGHT	HI PASS	Linkwitz	80 Hz @12 dB	116,2 cm	70 W	130 W
1D	OUT 1	SUB WOOFER	LO PASS	Linkwitz	80 Hz @12 dB	121,8 cm	280 W	520 W

1D = Max power at suggested loads: 800 W

MEMORY CONFIGURATION:

Memory A: Acoustic

Memory B: Rhythm

***Listening Point:** Driver

5.4.3 PRESET 2: FRONT + BRIDGE SUBWOOFER

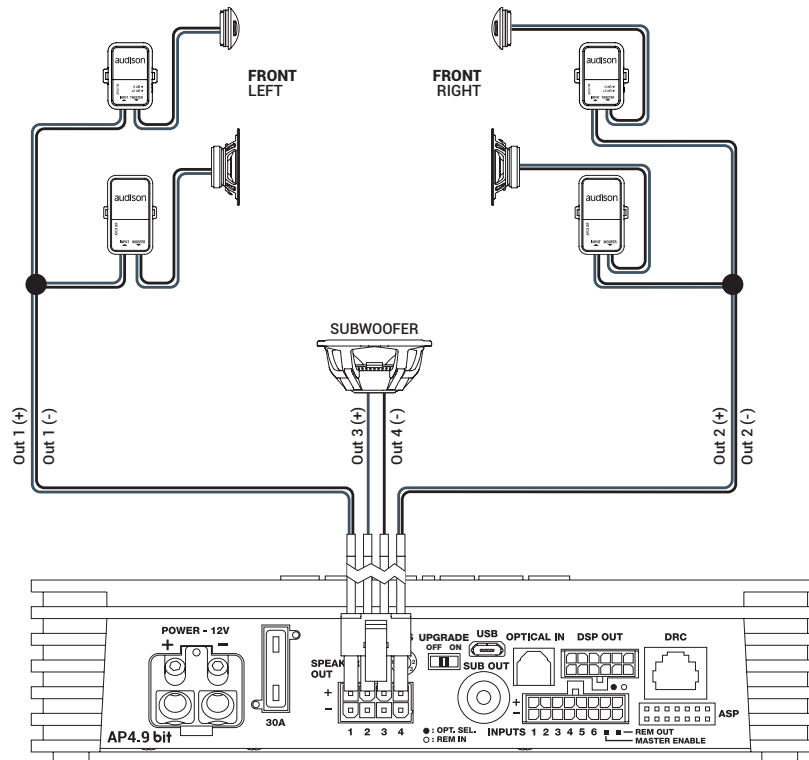
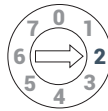

INPUT CONFIGURATION:

Master input: Front + Rear

Aux input: In1 + In 2

Optical: S/P-DIF PCM 96kHz/24 bit max

OUTPUT CONFIGURATION:

OUTPUT	TYPE	CUT FILTER	FILTER TYPE	CUT FREQUENCY	TIME ALIGNMENT*	POWER @ 4Ω	POWER @ 2Ω
OUT 1	FRONT LEFT	HI PASS	Linkwitz	80 Hz @12 dB	82,2 cm	70 W	130 W
OUT 2	FRONT RIGHT	HI PASS	Linkwitz	80 Hz @12 dB	116,2 cm	70 W	130 W
OUT 3+4	SUBWOOFER	LO PASS	Linkwitz	80 Hz @12 dB	121,8 cm	260 W	N. A.

■ = Max power suggested Loads: 400 W

MEMORY CONFIGURATION:

Memory A: Acoustic

Memory B: Rhythm

***Listening Point:** Driver

5.4.4 PRESET 3: HI POWER FRONT + EXTERNAL SUBWOOFER

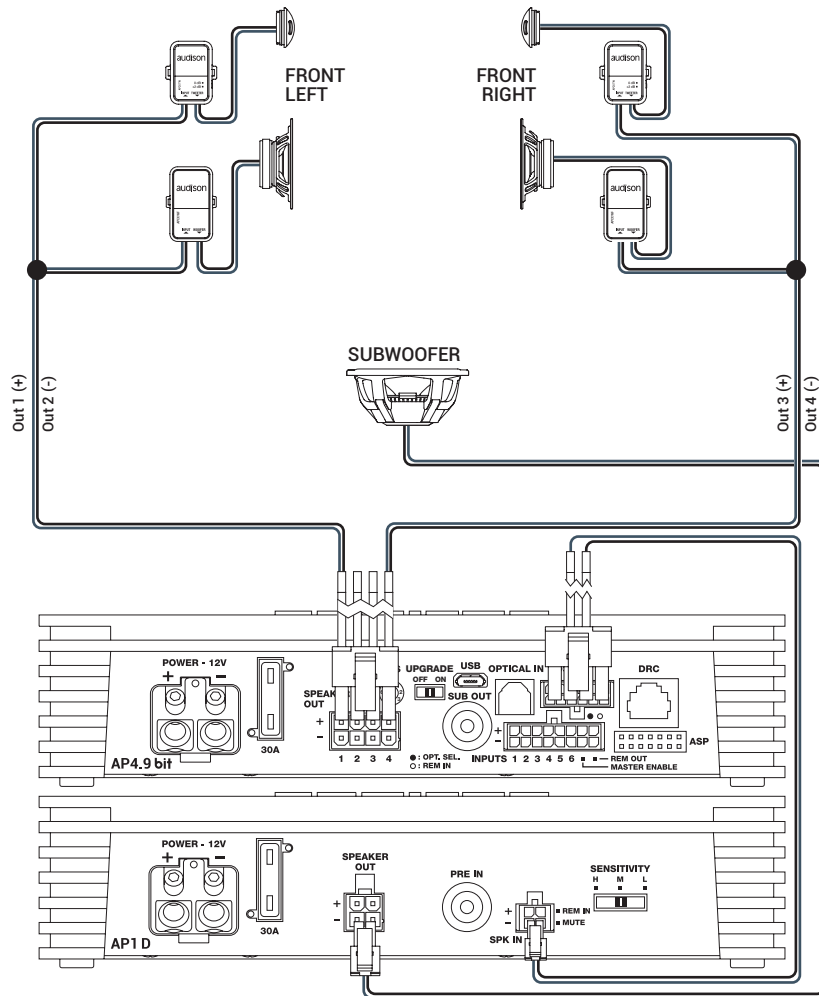
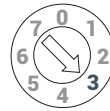

INPUT CONFIGURATION:

Master input: Front + AUX

Aux input: In1 + In 2

Optical: S/P-DIF PCM 96kHz/24 bit max

OUTPUT CONFIGURATION:

AP TYPE	OUTPUT	TYPE	CUT FILTER	FILTER TYPE	CUT FREQUENCY	TIME ALIGNMENT*	POWER @ 4Ω	POWER @ 2Ω
4.9 bit	OUT 1+2-	FRONT LEFT	HI PASS	Linkwitz	80 Hz @12 dB	82,2 cm	260 W	N. A.
4.9 bit	OUT 3+4-	FRONT RIGHT	HI PASS	Linkwitz	80 Hz @12 dB	116,2 cm	260 W	N. A.
1 D	OUT 1	SUBWOOFER	LO PASS	Linkwitz	80 Hz @12 dB	121,8 cm	260 W	520 W

■ = Max power suggested Loads: 1040 W

MEMORY CONFIGURATION:

Memory A: Acoustic

Memory B: Rhythm

***Listening Point:** Driver

5.4.5 PRESET 4: 3 WAY ACTIVE FRONT + SUBWOOFER

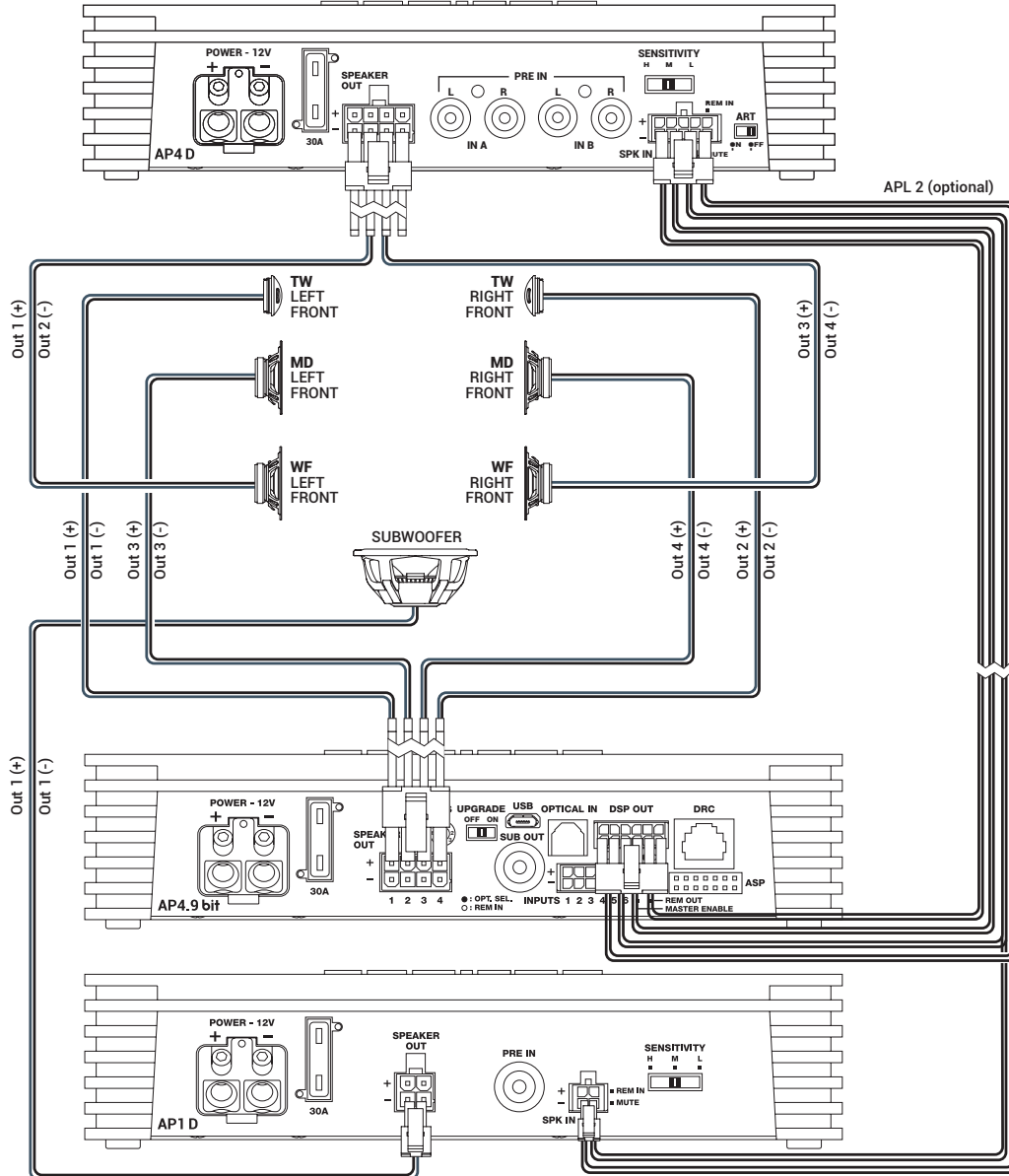
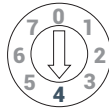

INPUT CONFIGURATION:

Master input: Front + AUX

Aux input: In1 + In 2

Optical: S/P-DIF PCM 96kHz/24 bit max

OUTPUT CONFIGURATION:

AP TYPE	OUTPUT	TYPE	CUT FILTER	FILTER TYPE	CUT FREQUENCY	TIME ALIGNMENT*	POWER @ 4Ω	POWER @ 2Ω
4.9 bit	OUT 1	FRONT TW LEFT	HI PASS	Linkwitz	3000 Hz @12 dB	82,2 cm	70 W	130 W
4.9 bit	OUT 2	FRONT TW RIGHT	HI PASS	Linkwitz	3000 Hz @12 dB	116,2 cm	70 W	130 W
4.9 bit	OUT 3	FRONT MD LEFT	BAND PASS	Linkwitz	500 Hz @12 dB 3000 HZ @ 12 dB	82,2 cm	70 W	130 W
4.9 bit	OUT 4	FRONT MD RIGHT	BAND PASS	Linkwitz	500 Hz @12 dB 3000 HZ @ 12 dB	116,2 cm	70 W	130 W
4D	OUT 1+ 2-	FRONT WF LEFT	BAND PASS	Linkwitz	80 Hz @12 dB 500 HZ @ 12 dB	82,2 cm	140 W	N. A.
4D	OUT 3+ 4-	FRONT WF RIGHT	BAND PASS	Linkwitz	80 Hz @12 dB 500 HZ @ 12 dB	116,2 cm	140 W	N. A.
1D	OUT 1	SUBWOOFER	LO PASS	Linkwitz	80 Hz @12 dB	121,8 cm	280 W	520 W

MEMORY CONFIGURATION:

Memory A: Acoustic

Memory B: Rhythm

*Listening Point: Driver

■ = Max power suggested Loads: 1080 W

5.4.6 PRESET 5: 3 WAY ACTIVE FRONT + REAR + SUBWOOFER

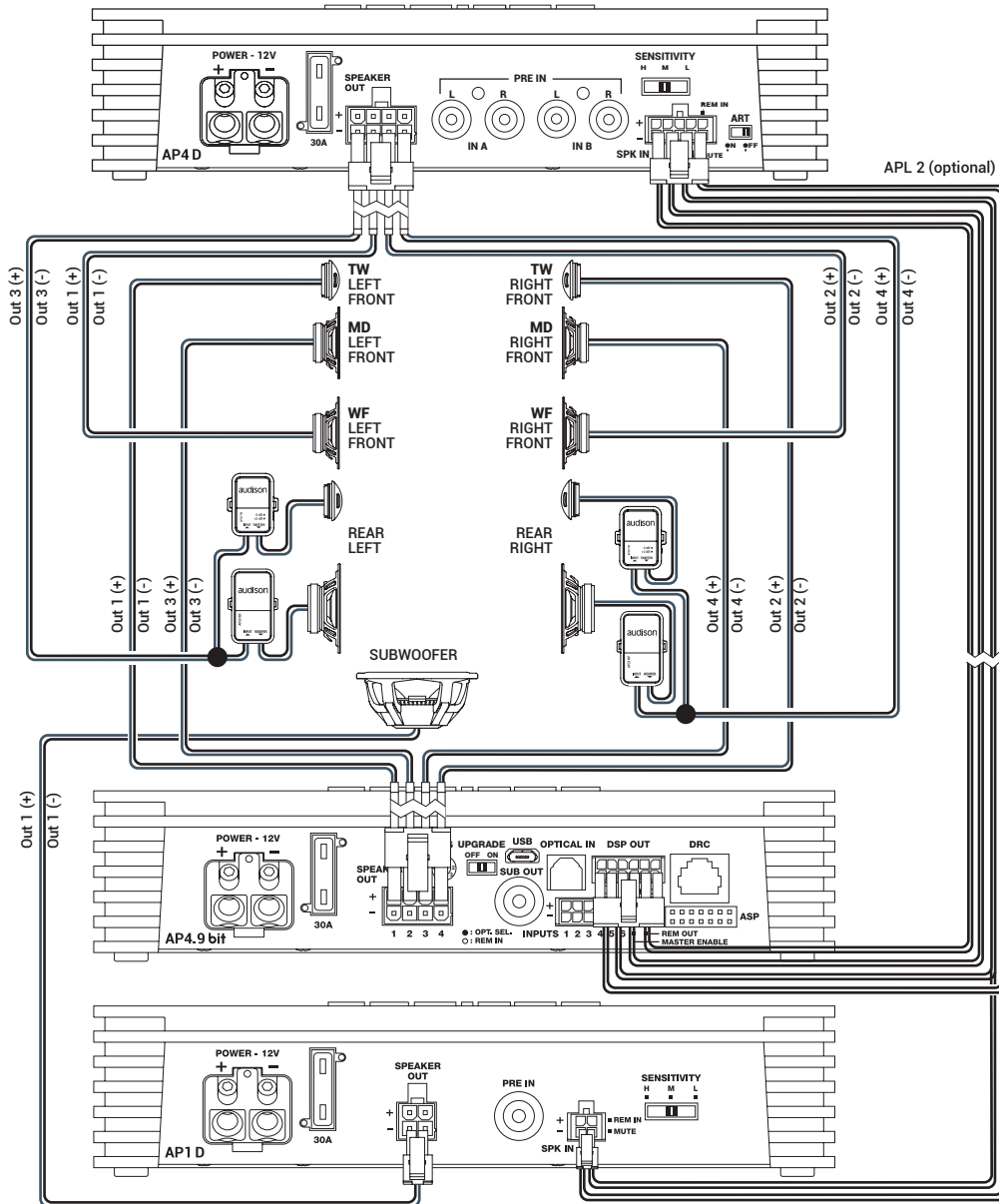

OUTPUT CONFIGURATION:

AP TYPE	OUTPUT	TYPE	CUT FILTER	FILTER TYPE	CUT FREQUENCY	TIME ALIGNMENT*	POWER @ 4Ω	POWER @ 2Ω
4.9 bit	OUT 1	FRONT TW LEFT	HI PASS	Linkwitz	3000 Hz @12 dB	82,2 cm	70 W	130 W
4.9 bit	OUT 2	FRONT TW RIGHT	HI PASS	Linkwitz	3000 Hz @12 dB	116,2 cm	70 W	130 W
4.9 bit	OUT 3	FRONT MD LEFT	BAND PASS	Linkwitz	500 Hz @12 dB 3000 Hz @ 12 dB	82,2 cm	70 W	130 W
4.9 bit	OUT 4	FRONT MD RIGHT	BAND PASS	Linkwitz	500 Hz @12 dB 3000 Hz @ 12 dB	116,2 cm	70 W	130 W
4 D	OUT 1	FRONT WF LEFT	BAND PASS	Linkwitz	80 Hz @12 dB 500 Hz @ 12 dB	82,2 cm	70 W	140 W
4 D	OUT 2	FRONT WF RIGHT	BAND PASS	Linkwitz	80 Hz @12 dB 500 Hz @ 12 dB	116,2 cm	70 W	140 W
4 D	OUT 3	REAR LEFT	HI PASS	Linkwitz	80 Hz @12 dB	62,3 cm	70 W	140 W
4 D	OUT 4	REAR RIGHT	HI PASS	Linkwitz	80 Hz @12 dB	116,2 cm	70 W	140 W
1 D	OUT 1	SUBWOOFER	LO PASS	Linkwitz	80 Hz @12 dB	121,8 cm	280 W	520 W

■ = Max power suggested Loads: 1080 W

INPUT CONFIGURATION:

Master input: Front + Rear
Aux input: In1 + In 2
Optical: S/P-DIF PCM 96kHz/24 bit max

MEMORY CONFIGURATION:

Memory A: Acoustic
Memory B: Rhythm

*Listening Point: Driver

5.4.7 PRESET 6: 2 WAY ACTIVE FRONT + REAR + SUBWOOFER

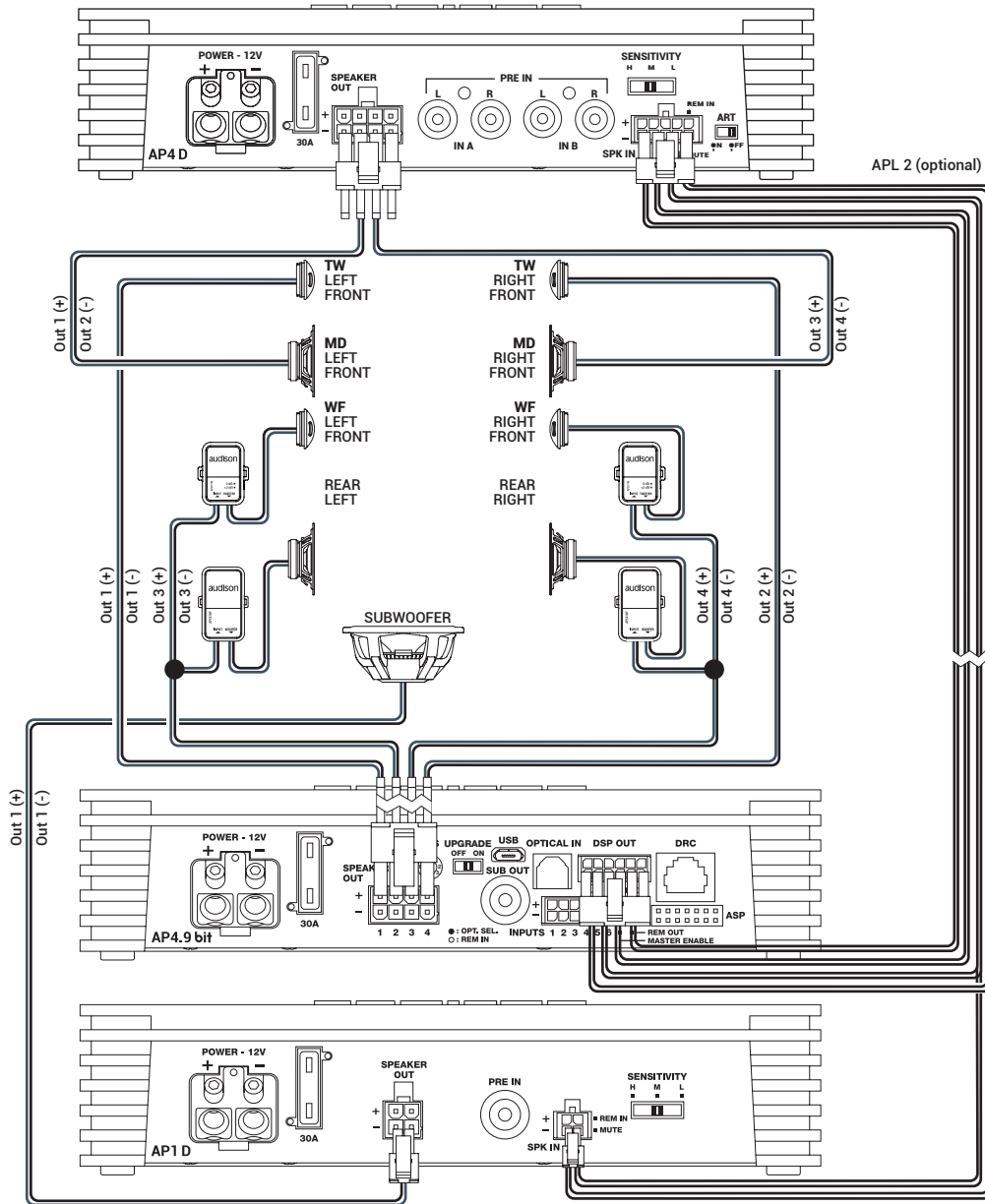
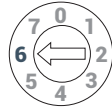

OUTPUT CONFIGURATION:

AP TYPE	OUTPUT	TYPE	CUT FILTER	FILTER TYPE	CUT FREQUENCY	TIME ALIGNMENT*	POWER @ 4Ω	POWER @ 2Ω
4.9 bit	OUT 1	FRONT TW LEFT	HI PASS	Linkwitz	3000 Hz @12 dB	82,2 cm	70 W	130 W
4.9 bit	OUT 2	FRONT TW RIGHT	HI PASS	Linkwitz	3000 Hz @12 dB	116,2 cm	70 W	130 W
4 D	OUT 1+2-	FRONT WF LEFT	BAND PASS	Linkwitz	80 Hz @12 dB 3000 HZ @ 12 dB	82,2 cm	260 W	N. A.
4 D	OUT 3+4-	FRONT WF RIGHT	BAND PASS	Linkwitz	80 Hz @12 dB 3000 HZ @ 12 dB	116,2 cm	260 W	N. A.
4.9 bit	OUT 3	REAR LEFT	HI PASS	Linkwitz	80 Hz @12 dB	62,3 cm	70 W	130 W
4.9 bit	OUT 4	REAR RIGHT	HI PASS	Linkwitz	80 Hz @12 dB	116,2 cm	70 W	130 W
1 D	OUT 1	SUBWOOFER	LO PASS	Linkwitz	80 Hz @12 dB	121,8 cm	280 W	520 W

■ = Max power suggested Loads: 1320 W

INPUT CONFIGURATION:

Master input: Front + Rear
Aux input: In1 + In 2
Optical: S/P-DIF PCM 96kHz/24 bit max

MEMORY CONFIGURATION:

Memory A: Acoustic
Memory B: Rhythm

***Listening Point:** Driver

5.4.8 PRESET 7: 2 WAY ACTIVE FRONT + 2 WAY ACTIVE CENTER + REAR + SUBWOOFER

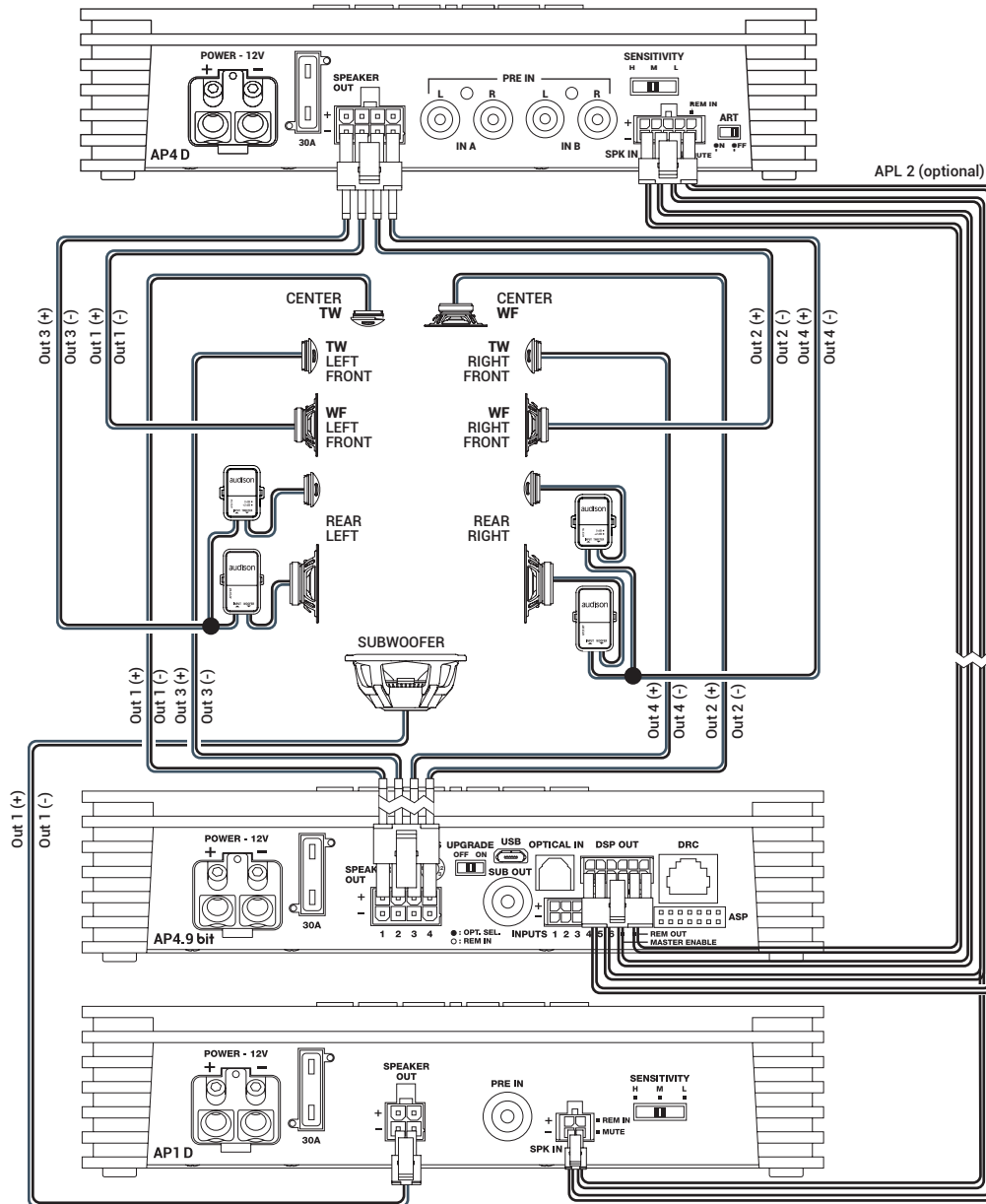

OUTPUT CONFIGURATION:

AP TYPE	OUTPUT	TYPE	CUT FILTER	FILTER TYPE	CUT FREQUENCY	TIME ALIGNMENT*	POWER @ 4Ω	POWER @ 2Ω
4.9 bit	OUT 1	CENTRE TW	HI PASS	Linkwitz	3000 Hz @12 dB	79,3 cm	70 W	130 W
4.9 bit	OUT 2	CENTRE WF	BAND PASS	Linkwitz	300 Hz @12 dB 3000 HZ @ 12 dB	79,3 cm	70 W	130 W
4.9 bit	OUT 3	FRONT TW LEFT	HI PASS	Linkwitz	3000 Hz @12 dB	82,2 cm	70 W	130 W
4.9 bit	OUT 4	FRONT TW RIGHT	HI PASS	Linkwitz	3000 Hz @12 dB	116,2 cm	70 W	130 W
4 D	OUT 1	FRONT WF LEFT	BAND PASS	Linkwitz	80 Hz @12 dB 3000 HZ @ 12 dB	82,2 cm	70 W	140 W
4 D	OUT 2	FRONT WF RIGHT	BAND PASS	Linkwitz	80 Hz @12 dB 3000 HZ @ 12 dB	116,2 cm	70 W	140 W
4 D	OUT 3	REAR LEFT	HI PASS	Linkwitz	80 Hz @12 dB	62,3 cm	70 W	140 W
4 D	OUT 4	REAR RIGHT	HI PASS	Linkwitz	80 Hz @12 dB	116,2 cm	70 W	140 W
1 D	OUT 1	SUBWOOFER	LO PASS	Linkwitz	80 Hz @12 dB	121,8 cm	280 W	520 W

■ = Max power suggested Loads: 1080 W

INPUT CONFIGURATION:

Master input: Front + Rear
Aux input: In1 + In 2
Optical: S/P-DIF PCM 96kHz/24 bit max

MEMORY CONFIGURATION:

Memory A: Acoustic
Memory B: Rhythm

*Listening Point: Driver

5.5 PERSONAL COMPUTER E DIGITAL REMOTE CONTROL (DRC)

1. Connecting AP4.9 bit to the PC

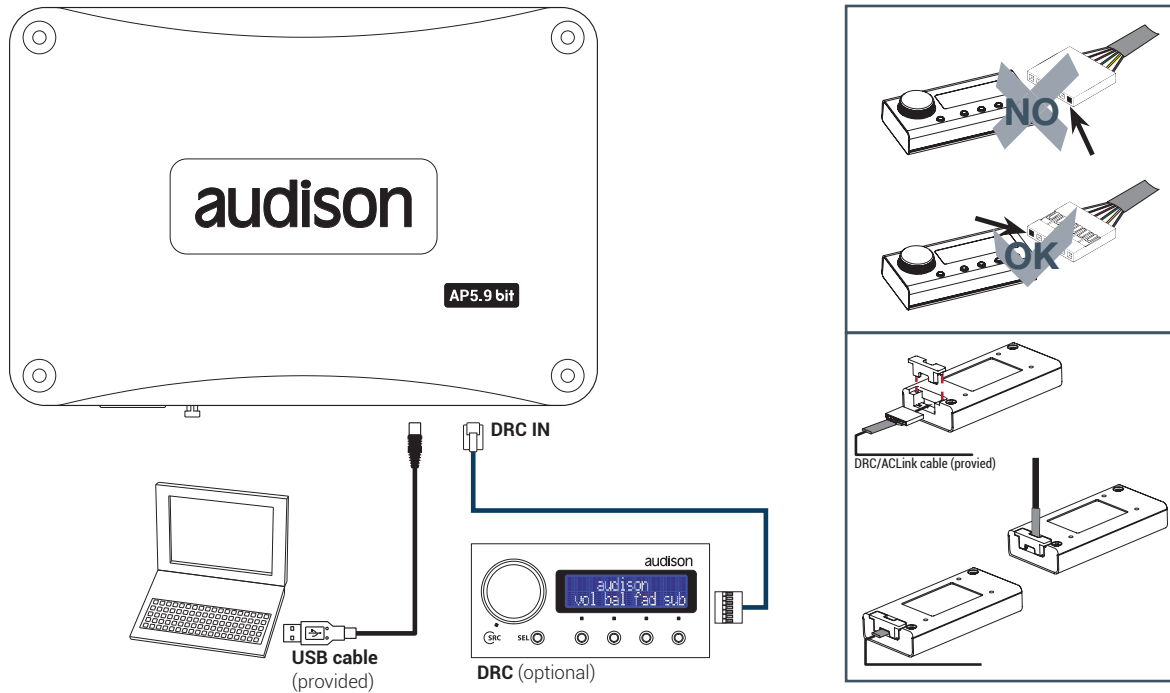

6. GUIDE FOR INSTALLING/UNINSTALLING Prima SOFTWARE AND DRIVERS

6.1 GUIDED PROCEDURE FOR PC SOFTWARE INSTALLATION

1. Insert the "AP4.9 bit Setup CD 1.0" in the drive on the PC you wish to use.
2. **Windows XP:** access My Computer from the Windows **START** menu;
Windows Vista: access Computer from the Windows **START** menu;
Windows 7: access Computer from the Windows **START** menu;
Windows 8: access the **Desktop** from Windows 8 **MAIN** menu;

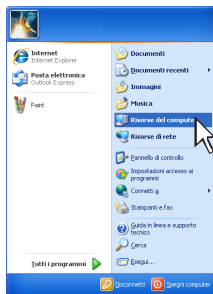

Windows XP

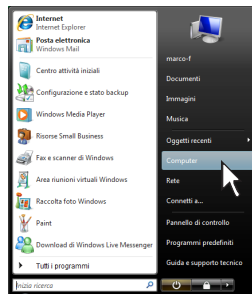

Windows Vista

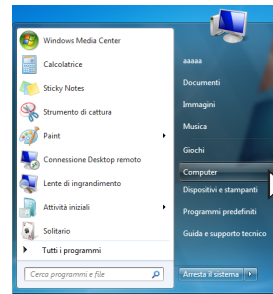

Windows 7

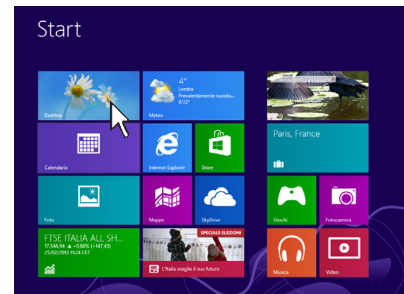

Windows 8

3. **Windows XP:** right click on the icon for the "AP4.9 bit Setup CD 1.0" and click on **Explore**;
Windows Vista: right click on the icon for the "AP4.9 bit Setup CD 1.0" and click on **Explore**;
Windows 7: right click on the icon for the "AP4.9 bit Setup CD 1.0" and click on **Open**;
Windows 8: access **Computer** from the Windows 8 menu;

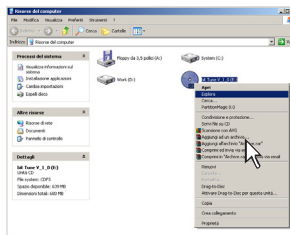

Windows XP

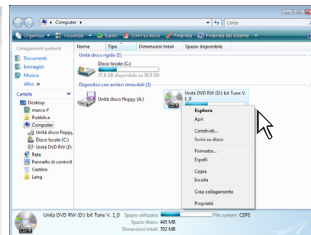

Windows Vista

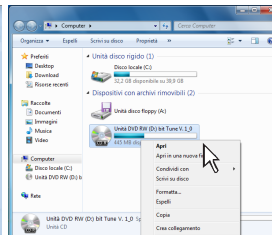

Windows 7



Windows 8

4. **Windows XP:** double click on the **setup** icon;
Windows Vista: double click on the **setup** icon;
Windows 7: double click on the **setup** icon;
Windows 8: select the CD drive and double click on the **setup** icon;

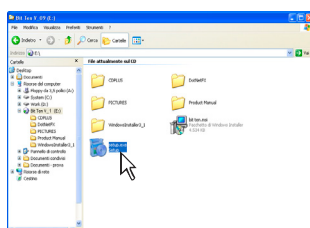

Windows XP

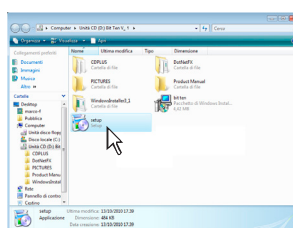

Windows Vista

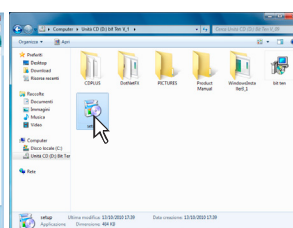

Windows 7

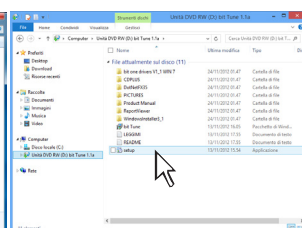

Windows 8

5. **Windows XP:** select **NEXT** to continue with the installation or **CANCEL** to interrupt it;
Windows Vista: select **NEXT** to continue with the installation or **CANCEL** to interrupt it;
Windows 7: select **NEXT** to continue with the installation or **CANCEL** to interrupt it;
Windows 8: select **NEXT** to continue with the installation or **CANCEL** to interrupt it;

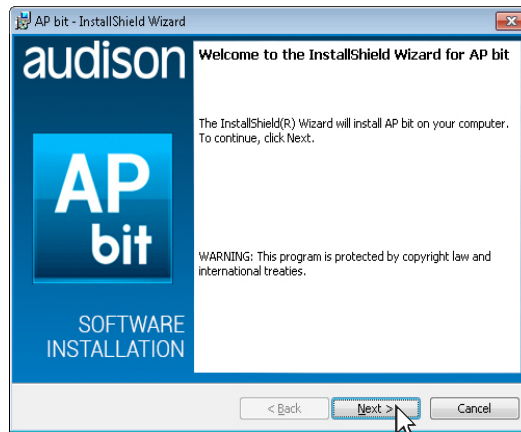

6. **Windows XP:** Select **I accept the terms in the license agreements** on the tab and then **NEXT**;
Windows Vista: Select **I accept the terms in the license agreements** on the tab and then **NEXT**;
Windows 7: Select **I accept the terms in the license agreements** on the tab and then **NEXT**;
Windows 8: Select **I accept the terms in the license agreements** on the tab and then **NEXT**;

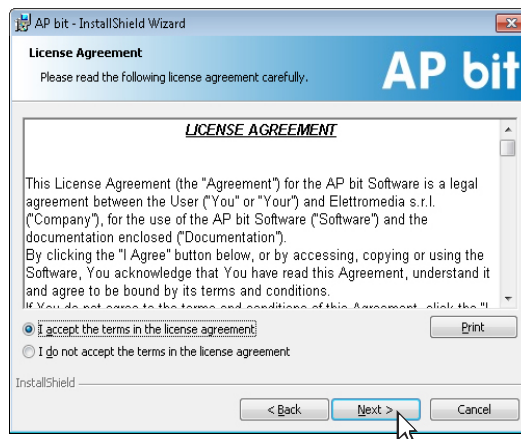

7. **Windows XP / Vista / 7 / 8:** select
 - **Install** to proceed with the installation;
 - **Back** if you wish to return to the previous page;
 - **Cancel** to exit installation;
 Then click **NEXT**.

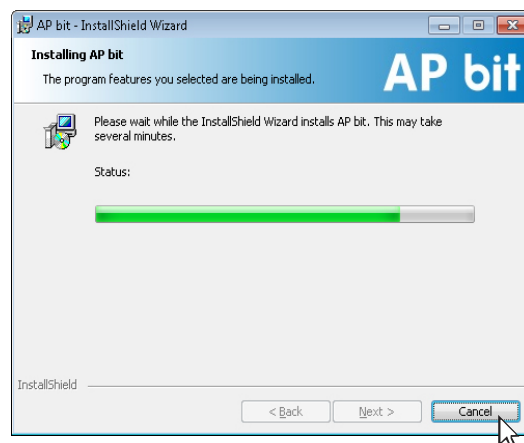
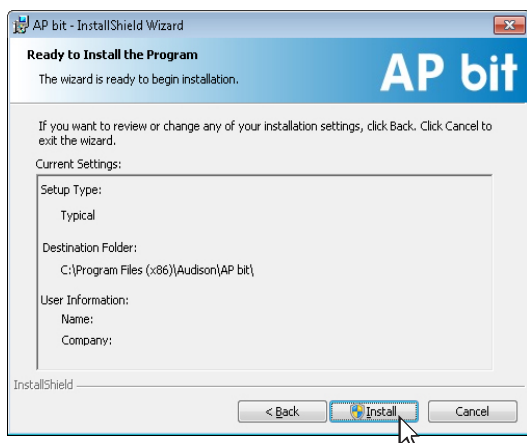

8. **Windows XP:** follow and complete the installation procedure and click **FINISH** at the end of the installation;
- Windows Vista:** follow and complete the installation procedure and click **FINISH** at the end of the installation;
- Windows 7:** follow and complete the installation procedure and click **FINISH** at the end of the installation;
- Windows 8:** follow and complete the installation procedure and click **FINISH** at the end of the installation;

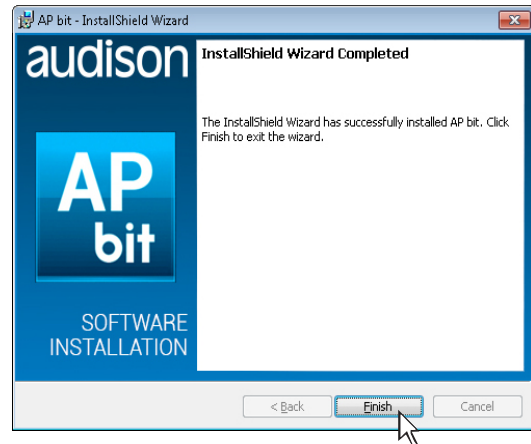

6.2 GUIDED PROCEDURE FOR DRIVER INSTALLATION

1. Turn on **AP4.9 bit**
2. Connect the USB cable on the connector on **AP4.9 bit** to a free USB port on the PC.

WARNING: When connecting a laptop via USB to **AP4.9 bit** while it is turned on, the laptop has to work with its own battery and stay disconnected from the mains adapter (external power supply). Once the connection between the laptop and **AP4.9 bit** has been established, you can immediately connect the computer, if necessary, to the mains adapter.

3. **Windows XP:** the PC will recognize **AP4.9 bit** interface and installation will start automatically;

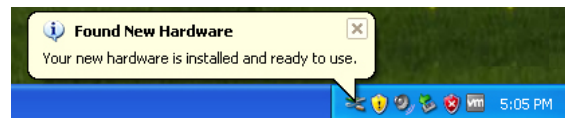

Windows Vista: the PC will recognize **AP4.9 bit** interface and installation will start automatically;

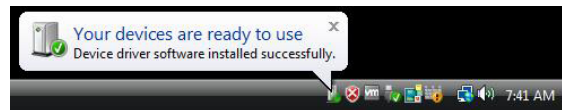

Windows 7: the PC will recognize **AP4.9 bit** interface and installation will start automatically;

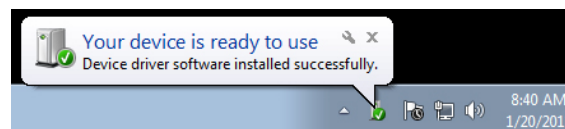

Windows 8: the PC will recognize **AP4.9 bit** interface and installation will start automatically;

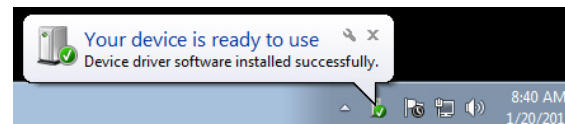

4. The peripheral device has been installed correctly and is ready for use.

***Remark:** AP4.9 bit uses the HID drivers already built into Windows. For this reason, they are not included on the CD and will always install automatically.

6.3 UNINSTALLING AP4.9 bit SOFTWARE

Procedure 1

To uninstall **AP4.9 bit** PC software you can use the link in the menu:

Start / All programs / AP4.9 bit / uninstall



Procedure 2

To uninstall **AP4.9 bit** PC software, you can also use the standard procedure:

Start / Control Panel / Uninstall or change a program / AP4.9 bit / remove.



7. HOW TO SET UP AP4.9 BIT WITH A PC

7.1 OFFLINE MODE

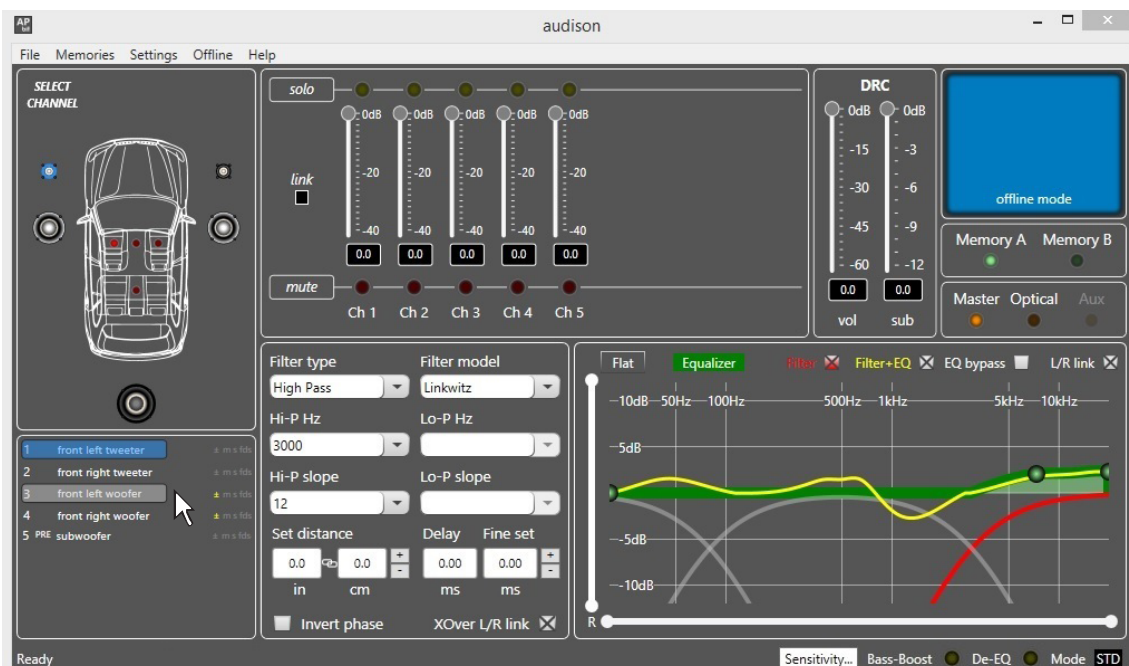
OFFLINE mode can be used to analyze the software without connecting **AP4.9 bit** to the PC to become familiar with the numerous functions of the processor. (For specific functions, see **TARGET mode section 7.2**). To activate the **OFFLINE** mode, the device must be disconnected from the PC. The software is preset to start with a 3 way active FRONT + REAR full multi-amplified system. To set a new "virtual" system and thus change the inputs and select the outputs, select the function **Configuration Wizard** in the **SETTINGS** window of the software main menu.



Remark: Change the size of the window for the PC software.

- To make the window full-screen, click on the Enlarge button  or double click on the title bar of the PC Software window.
- To restore the previous size from full-screen, click on the Reset button  or double click on the title bar on the window.
- To resize the PC Software window (make it smaller or larger), position the mouse pointer on one edge or corner of the window. When the mouse pointer becomes an arrow with a double point, drag the edge or corner to make the window larger or smaller.

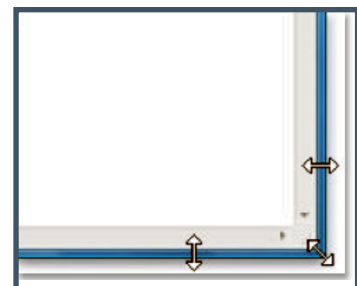

7.2 TARGET MODE

In order to configure the inputs, amplified and pre-amplified power outputs, EQ and time delays for **AP4.9 bit**, it must be interfaced with the PC. When you get to this point you must already be aware of what type of system you intend to set up. In order to change these choices at a later date, you will need to perform the guided procedure again.

The guided procedure will ask:

- The type of specialization for the main input channels used. The guided procedure changes according to your choice.
- The type of signals that will be assigned to the main inputs (e.g.: Front Left or Center or Subwoofer, etc.).
- The speakers in the system (e.g.: 3 way Front or Sub Stereo or 2 way Rear, etc.).
- If there are passive crossovers that manage groups of speakers (e.g.: 3 way systems with active midrange).
- If you intend to use an external monophonic amplifier to drive a Subwoofer or an external amplified subwoofer.
- If you intend to use the amplified outputs on **AP4.9 bit** in BRIDGE configuration, thus increasing the power on the output.

WARNING: During this operation, we recommend disconnecting the power connector from **AP4.9 bit** to the speakers, disconnecting the **SPEAKER OUT** connection. ([see sec. 4.4](#))



1. Connect the speaker outputs or the **Pre Out** outputs from the **INPUTS** on **AP4.9 bit** ([see sec. 4.2](#)). Before turning on the system, make sure the power outputs are disconnected from **AP4.9 bit** to avoid damaging the speakers during calibration.

The input calibration operation must be performed with the vehicle engine running. In this case, the voltage is about 14.0 V. The source will provide an undistorted output signal at higher volume.

2. Turn on **AP4.9 bit** and connect the USB cable to the PC. Start **AP4.9 bit** software by clicking on the icon on the PC Desktop that was created upon installation.

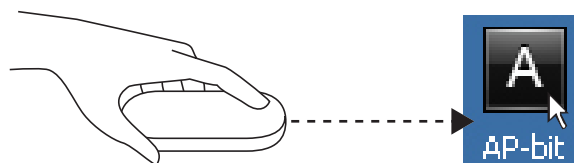

3. If synchronization is successful, a communication window will appear that shows the data exchange between the processor and software. Wait a few seconds.

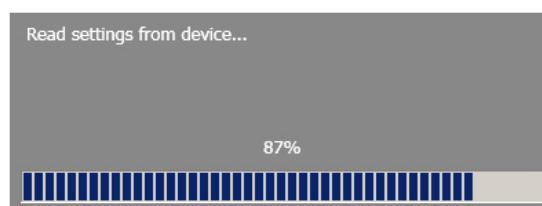

4. Click on the **Settings** menu and select **Configuration Wizard**.

Press **Start** to continue with the configuration.
Press **Cancel** to exit the procedure.

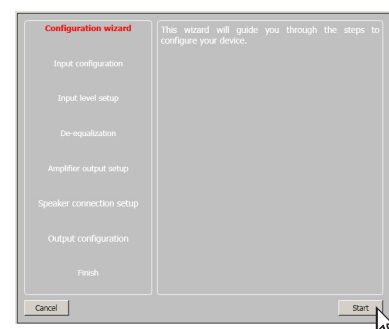
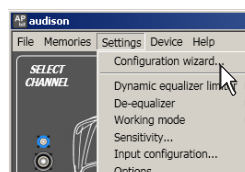

5. Input Configuration

Any of the input channels on AP4.9 bit can be given the name corresponding to the signal coming from the source. Choose one of the following input configurations:

- **(1) F + R + AUX** : controls Front stereo + Rear stereo + AUX input. It is possible to select from the drop-down menu which input sections to use to drive the subwoofer in the audio system. The subwoofer channel /s can be driven either by the input signal coming from the Front line, or by the input signal coming from the Rear line or by the one coming from the mix of Front+Rear lines.
- **(2) 2 WAY F + R**: controls a 2 way active Front stereo + Rear stereo. It is possible to select from the drop-down menu which input sections to use to drive the subwoofer in the audio system. The subwoofer channel /s can be driven either by the input signal coming from the Front line, or by the input signal coming from the Rear line or by the one coming from the mix of Front+Rear lines.
- **(3) F + R + SUB L/R**: controls Front stereo + Rear stereo + SUB stereo;
- **(4) F + R + SUB**: controls Front stereo + Rear stereo + SUB mono;
- **(5) F + R + C + SUB**: controls Front stereo + Rear stereo + Center + Sub;
- **(6) F + AUX** : controls Front stereo + AUX stereo;
- **(7) 2 WAY F + AUX**: controls a 2 way active Front stereo + AUX stereo;
- **(8) 2 WAY F + SUB L/R**: controls a 2 way active Front stereo + SUB stereo;
- **(9) 2 WAY F + SUB L/R**: controls a 2 way active Front stereo + SUB mono

(1) F + R + AUX

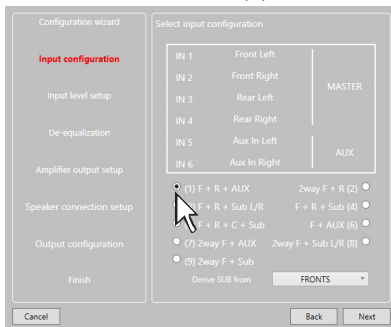

(2) 2 WAY F + R

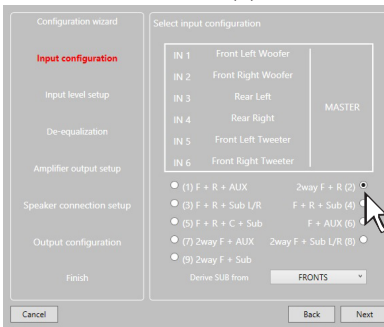

(3) F + R + SUB L/R

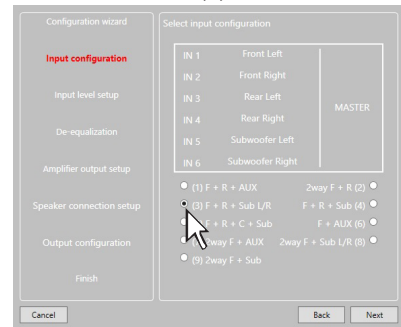

(4) F + R + SUB



(5) F + R + C + SUB

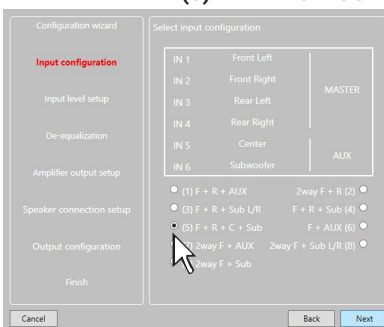

(6) F + AUX

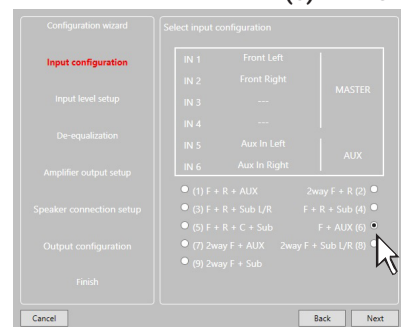

(7) 2 WAY F + AUX

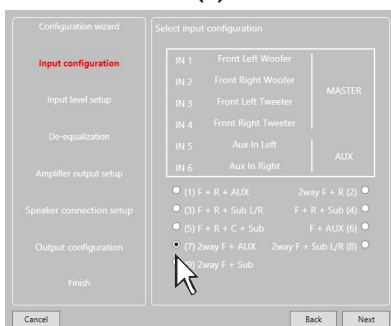

(8) 2 WAY F + SUB L/R

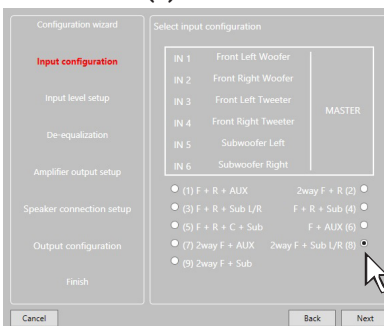

(9) 2 WAY F + SUB

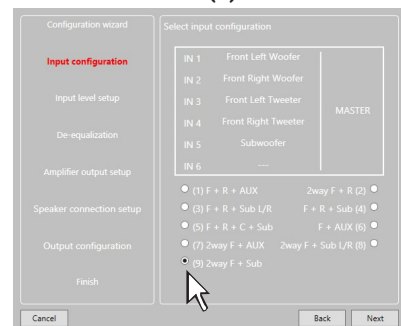

AP4.9 bit will use these names to reconstruct a full band signal coming from an OEM source with a dedicated multichannel amplifier and to assign the corresponding signal to the respective output.

- Press **BACK** to return to the previous step.
- Press **NEXT** to continue with the configuration.
- Press **CANCEL** to exit the procedure.

6. Input Level Setup.

- Play track 1 from the CD provided with **AP4.9 bit**.

Remark: if the head unit used is not equipped with a CD player, and only features a USB input, follow the instructions below.

- 1) Copy the tracks in Wav format from the CD to the USB storage device.
 - 2) Copy the tracks in mp3 format from the folder in the setup CD to the USB storage device, in case the first player is not suitable to reproduce Wav formats.
- Set all tone controls to zero (flat).
 - Set balance and fader to center.
 - Adjust the head unit volume to the maximum undistorted output level.
 - If the head unit provides an adjustable equalizer, make sure that the controls are set to zero (flat).

Select:

- **0dB Reference:** setup related to the use of music tracks recorded at 0dB.
- **Musical setup:** for the use of music tracks recorded at a level lower than 0dB (-3dB ÷ -6dB).

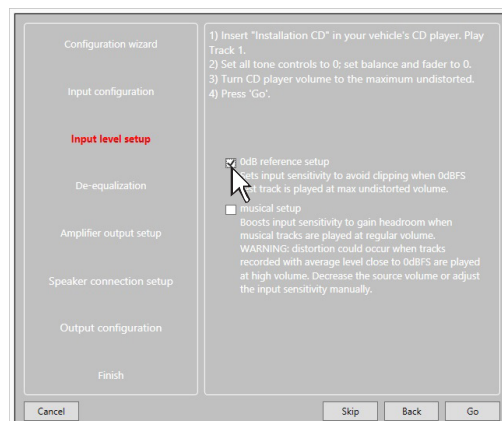

- Press **BACK** to return to the previous step.
- Press **GO** to continue with the configuration.
- Press **CANCEL** to exit the procedure.
- Press **SKIP** to skip the level calibration procedure

The input level calibration procedure is a delicate operation and must be performed very carefully. If not performed correctly, it can nullify the final sound results.

WARNING: The head unit level must be adjusted to the maximum undistorted level. If the initial head unit distortion level can not be determined, adjust the volume to approximately 80% of its maximum. If the head unit output level is set **too low**, the device may produce ground noise (hissing sound) when playing music tracks. This is due to the low signal / noise ratio provided by the head unit to the **AP4.9 bit** input. If you experience this problem, after **calibrating the amplifiers sensitivity levels**, increase the head unit volume and repeat the **AP4.9 bit** calibration procedure as detailed in point 9 of this paragraph

WARNING: Some factory head units require a low load impedance to be able to activate the outputs (usually the Rear section). If you cannot adjust the input signal level during the calibration procedure, it may be necessary to connect the **ASP** module in parallel to the input cables for the channels with the error (see sec. 4.3)

The check for whether or not the **ASP** module is needed on **AP4.9 bit** can be performed using the bit Tune SPEAKER SIMULATOR tool (see sec. 8.1 bit Tune Advanced Manual).

Head units output level instrument check

The maximum output voltage and maximum undistorted level can be measured using the **Audison bit Tune SOURCE CHECK** tool (see sec. 7.1 bit Tune Advanced Manual).

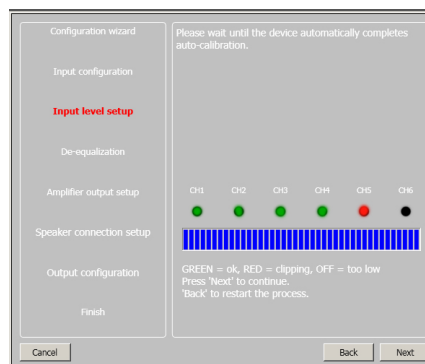

7. De-equalization.

De-equalization of the OEM source, operation not required and not necessary if using low level inputs (Pre out). During the high level input configuration procedure, this function can be used to maximize use of the OEM head units, even if they were equalized to adapt best to the acoustics of the car they are installed in. The de-equalization procedure performs an analysis of the electrical frequency response coming from the various channels on the OEM head unit and automatically applies an equalization opposite to the original one, generating a linear signal that is much more suitable to driving high quality audio systems. Regardless of the input channels used, the de-equalization will be performed by functional groups.

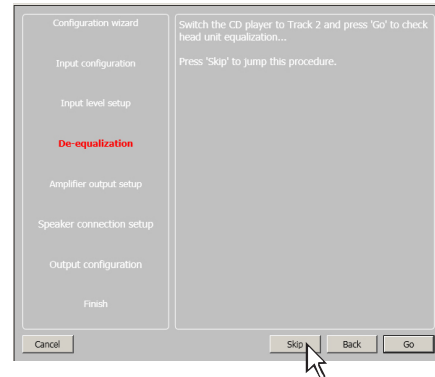

E.g.: Even if using Front Left Full and Front Right Full as inputs, the software will also perform the de-equalization on the Rear, Center and Subwoofer since the processor must use the signals identified as Front to also control any possible Rear, Center and Subwoofer outputs.

If you decide to perform this procedure, follow the instructions below:

- Insert the supplied Setup CD if the source used is an audio CD player;
- Play track 2 (press Play);
- Set all of the tone controls to zero (0).
- Set the balance and fader to the center (0).
- Don't change the adjusted volume previously set through the automatic input level calibration;

- Press **BACK** to return to the previous step.
- Press **GO** to continue with the configuration.
- Press **SKIP** to abandon the procedure.
- Press **CANCEL** to exit the program.

The software uses a progress bar and specific messages to show how the procedure is being executed. At the end of the procedure, the window will show the equalization curves for the head unit.

- Press **BACK** to return to the previous step.
- Press **NEXT** to continue with the configuration.
- Press **CANCEL** to exit the program.

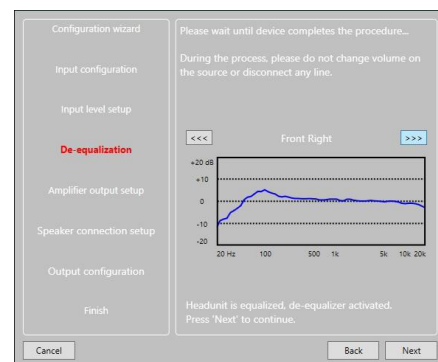

8. Amplifier Output Setup.

This window shows the output channels setup. There are 4 output channels which may be extended to 9 with the AP4 D / AP1 D amplifier menu.

- Press **BACK** to return to the previous step.
- Press **NEXT** to continue with the configuration.
- Press **CANCEL** to exit the program.

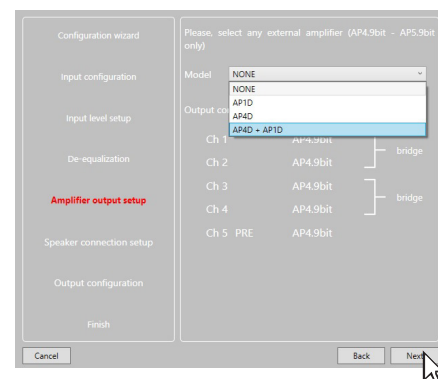

9. Speaker Connection Setup.

The speakers present in the system can be activated by simply clicking on them.
The software assumes that if the Left tweeter, midrange or woofer are selected, the Right ones are also activated.
Once the software is started, this choice will affect the crossover type and frequencies with Default settings.
If passive crossover filters are not used, each speaker corresponds to an output channel.

Selection of passive crossovers for groups of speakers

The presence of passive crossovers managing functional speaker groups can be indicated.

E.g.: If the audio system features passive crossovers, the software will ask you to set them by clicking on , otherwise press **NEXT**.
A 2 or 3 way passive crossover occupies a single output channel.

If the addition of crossovers and/or speakers exceeds 4 channels for an AP4.9 bit or 9 channels for an AP4.9 bit + AP4 D + AP1 D, the software will not allow you to proceed to the next step. Double-check the crossover configuration or the speaker setup through the **BACK** button.

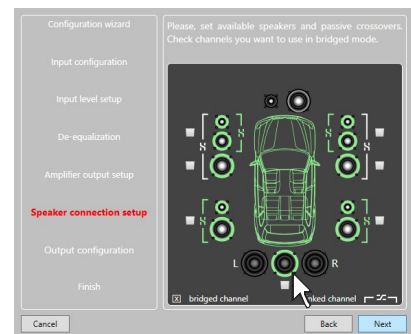
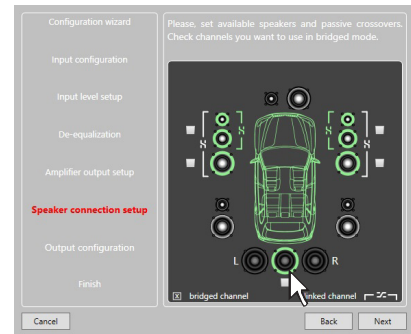

WARNING: One coaxial speaker is considered as a  Tweeter + Woofer + 2 way passive crossover.

Select Bridge Mode outputs for groups of speakers.

In order to increase the front driving power, you can set the AP4 D outputs connected to the AP4.9 bit in BRIDGE mode by selecting the check box as shown.

Press **BACK** to return to the previous step.
Press **NEXT** to continue with the configuration.
Press **CANCEL** to exit the procedure.

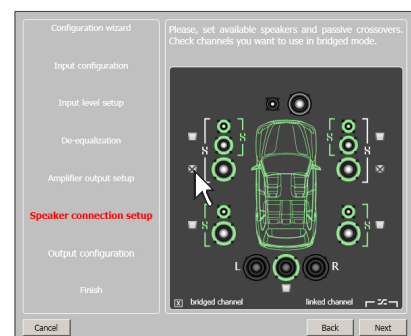

10. Output Configurations.

The AP4.9 bit features 4 output channels. In this specific step of the procedure, you can assign any signal to one of the output channels, taking into account, however, the diversity of the available power outputs ([see section 5.4.1](#))

Ex.: The 2-way front can be run as:

- Medium to high passive + separately amplified woofer (4 output channels are needed);

When selecting the output channels, the software will show when the maximum of 5 is respected, remove prior warning messages and display the **NEXT** button.

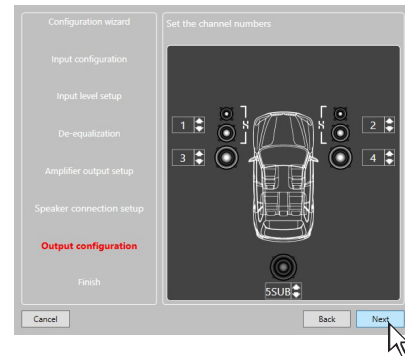

Press **BACK** to return to the previous step.
Press **NEXT** to continue with the configuration.
Press **CANCEL** to exit the procedure.

11. Finish.

Stop playing the Test track and remove the setup CD from the source player.

Press **BACK** to return to the previous step.
Press **CANCEL** to exit the procedure.
Press **FINISH** to end the configuration.

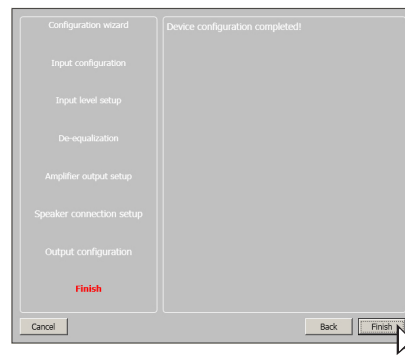

12. Software startup

The software transfers to the central processor memory the settings selected during the guided procedure. At the end of this operation, an update confirmation will appear. Press **OK**.

The product will now have to be finalized to avoid the data saved during calibration ([see sec. 7.3.5.2](#)).using the function **FINALIZE the device**.

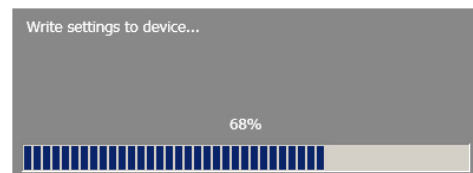

7.3 ADJUSTING ACOUSTIC REPRODUCTION

The following paragraphs describe the functions to adjust the system and its acoustic fine tuning.

WARNING: When exploring the functions, do not change the parameters on **AP4.9 bit**. Take your time to get familiar with the possibilities the software offers.



If you choose to leave the speakers/amplifiers connected to **AP4.9 bit**, remember to make adjustments with a general volume that won't damage the other speakers in the system. (see sec. 7.3.13.8)



7.3.1 DEVICE INFO

1

This window shows whether **AP4.9 bit** is properly interfaced with the PC and the DRC. It also shows the Firmware version for the device and the Serial Number.

7.3.2 FILE MAIN MENU 2

By clicking on the File tab, a drop-down menu appears with the entries shown in the image:

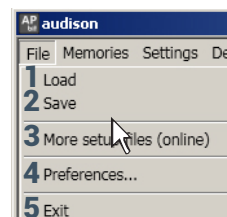

1. **Load:** it loads the entire **AP4.9 bit** configuration from a previously saved file (e.g.: "AP4.9 bit setup1.ap"). This function is present in both **TARGET mode** and in **OFF LINE** mode. In **TARGET** mode it can reload all of the previously saved settings. This function is useful if you wish to install another **AP4.9 bit** with the same settings. The input level calibration and, possibly, the De-Eq levels must be repeated. In **OFF LINE** mode, you can check the previously saved settings.

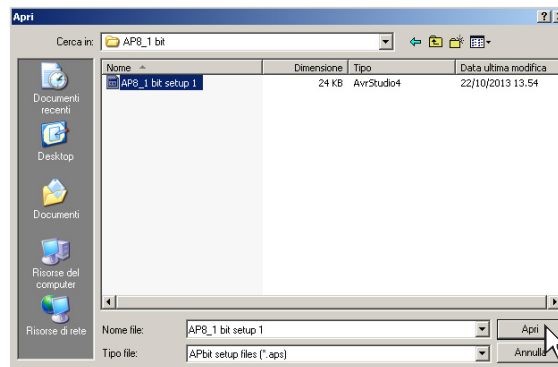

2. **Save Setup:** it saves the entire **AP4.9 bit** configuration for **AP4.9 bit** in one file (e.g.: "AP4.9Config.ap"), that can be reloaded later in **AP4.9 bit** using the **Load Setup** function. This function is present in both **TARGET** mode and in **OFF LINE** mode.

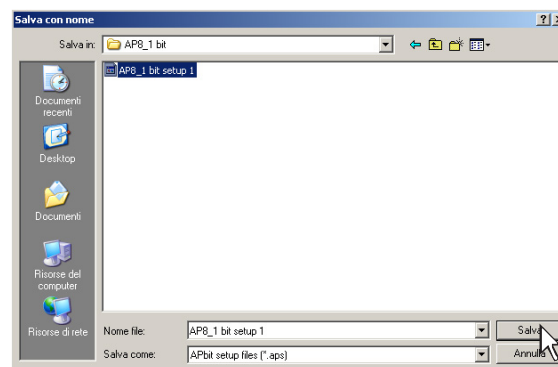

3. **More setup files (online):** This function requires an internet connection. By clicking on this entry, a link to download new installation setups appears.
4. **Preferences:** Lets you display the context messages in the chosen "Language" (Italian or English). The PC Software automatically defaults to English. To change the language, select language from the menu and restart the PC Software.

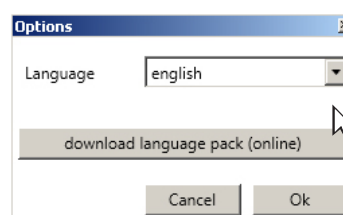

Remark: Other languages may also be available. Verify through "**Check for Updates**"

5. **Exit:** Exits the PC software.

7.3.3 MEMORIES MAIN MENU 3

By clicking on this item, a drop-down menu appears with the entries shown in the image:

1. **Copy A to B:** Copies the contents of memory A to memory B.
2. **Copy B to A:** Copies the contents of memory B to memory A.
3. **Reset current memories:** Resets the crossover and standard equalizer values, those that are proposed at the end of the configuration procedure.
4. **Load memory from file:** It loads a previously saved memory, by placing it in one of the two available memories.

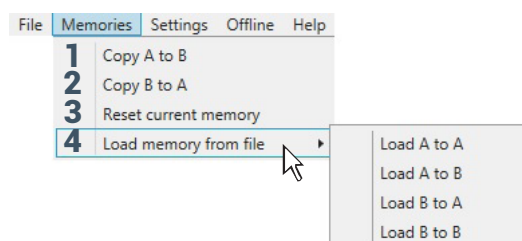

7.3.4 SETTINGS MAIN MENU 4

By clicking on this item, a drop-down menu appears with the entries shown in the image:

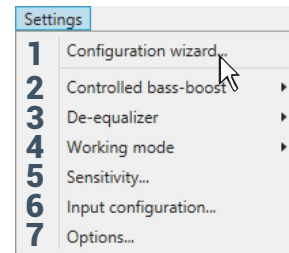

1. I/O Configuration Wizard: Sets up the system, and puts **AP4.9 bit** in the conditions needed to be able to perform this operation (see sec. 7.2).

WARNING: Whenever performing the **I/O Configuration Wizard**, the values set in the Options menu (see sec. 7.3.4.7) are set to the default values.

2. Controlled bass-boost: if enabled, through this function you can operate on the equalization of the sub channel and woofers. By clicking on Settings you can choose the parametric equalizer pole where you can operate and vary the "Q" factor by acting on the mouse wheel when available or using the keys "+" and "-" on the PC keyboard.

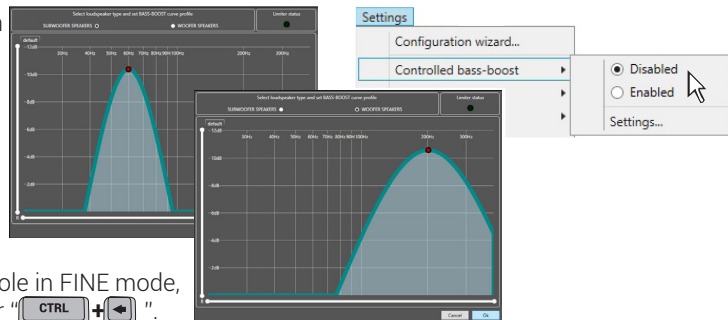

Remark: to select the frequency parametric pole in FINE mode, use the PC keyboard keys "CTRL + →" or "CTRL + ←".

When heavy equalization is set, the software will activate through soft clipping eliminating the subsequent distortions. This function can also be enabled and disabled via DRC MP. (see sec. 9.1).

3. De-Equalizer: If activated (**Enabled**), this function enables the de-equalization curve calculated during the **Configuration Wizard**. If the function is deactivated (**Disabled**) no source de-equalization curve is applied. The **Reset** command deletes the de-equalization curve calculated during the **Configuration Wizard**.

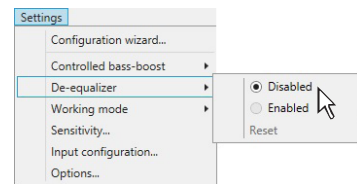

4. Working Mode: The software can work in two modes, acting on the crossover filter section.

Standard: simplified mode with some restrictions easing the use of the software (see sec. 7.3.10).

Expert: there are no restrictions in the software functions of use (see sec. 7.3.10).

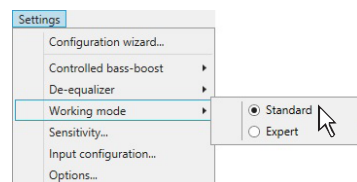

WARNING: switching from one mode to another resets the configuration of the filters to their original Default setting.

5. Sensitivity: Lets you display and adjust the sensitivity of **AP4.9 bit** inputs. To perform the sensitivity calibration, refer to sec. 7.2.6.

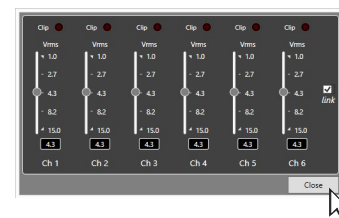

6. Input configuration: Shows the specialization assigned to the inputs on **AP4.9 bit** during the **Configuration wizard**.

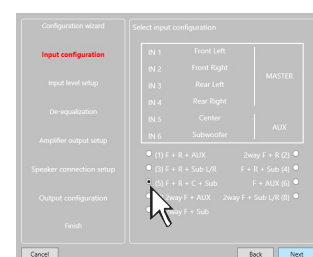

7. Options: By clicking on this item, a drop-down menu appears with the entries shown in the image:

Signals: Lets you set how **AP4.9 bit** is turned on through:

- **Turn ON by SPEAKER DC (ART):** When **Enabled** is selected, **AP4.9 bit** can be turned on through the amplified output (BTL) of a source connected to the inputs **FL-FR-RL-RR**. This function can be disabled by selecting **Disabled**.
- **Turning ON by SIGNAL PRESENCE (AST):** When **Enabled** is selected, **AP4.9 bit** can be turned on through the presence of a signal from a source connected to the inputs **FL-FR-RL-RR, IN1-IN2 (AUX)**. The stand-by time (energy saver) for the device when there is no signal can be set through the function **TIMES** -> **SLEEP time out for analog input** (see next point). The shut down time for the device when there is no signal is set to 30 mins. This function can be disabled by selecting **Disabled**.
- **Input selector:** Lets you specialize the "OPTICAL SEL" terminal for automatic selection of the **OPTICAL** or **AUX** input. It is also possible to specialize this terminal to turn on the product by clicking on "Enabled". If you choose to use the "OPTICAL SEL" terminal, it will be active by bringing it to + 12 V.

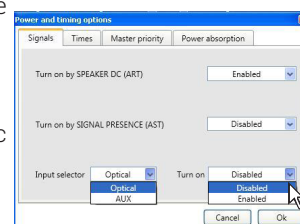
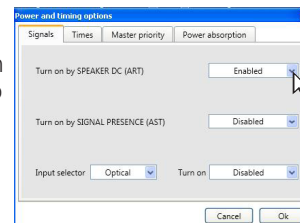

Times: Lets you change the settings for the times to turn **AP4.9 bit** on and off.

- **Remote OUT delay (sec):** This is the delay between disabling of the REMOTE OUT signal to the amplifiers and turning off **AP4.9 bit**. It is not usually necessary to change this parameter but it may be useful to decrease it whenever there are amplifiers that produce a turn off "Bump".
- **MUTE release delay (sec):** This is the delay between turning on the device and the activation of the output audio. Each amplifier has a turn on phase, its own delay before being operational. Setting Startup Time to a value equal to or greater than the longest delay will provide synchronized audio startup for the whole system.
- **SLEEP timeout for analog input (min):** it sets the amplifier's stand-by time when there is no audio signal. The stand-by time (energy saver) can be set from 1 min minimum to 20 mins maximum. Normal operation is resumed when the audio signal is present. This function is set on 20 minutes by default and can be enabled by selecting the desired amount of minutes. The **SLEEP timeout for analog input** function allows to save power and provides the ability for the product to work at lower temperatures.

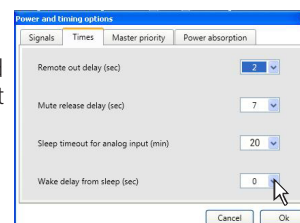

Remark: we recommend that the shortest possible activation time is selected in case of hybrid or electric propulsion cars; it won't affect the product normal operation.

- **Wake delay from sleep (sec):** It sets the amplifier resume delay from energy saver status. The delay time can be adjusted from a minimum of 0 sec. to a maximum of 5 secs. This function is set by default at 0 secs (disabled).

Remark: some factory (OEM) head units are provided with a control signal lasting approx. 2 secs during the turn-on phase to check if loudspeakers are in the system (see section 4.3). If the head unit is turned off while the car is being used, the AP4.9 bit, if turned on through ART, will keep working to let the security alerts, phone alerts, navigation system alerts etc. be reproduced. When the head unit is turned on again, the speaker presence control alerts may be reproduced. To avoid this happens, you can set the **Wake delay from sleep (sec)** duration at a value slightly higher than the duration of the speaker presence control alerts.

WARNING: If the car is equipped with security alerts, phone alerts, navigation system alerts, ...etc., if you set a too long Wake delay from sleep (sec), reproduction of the first part of the mentioned signals might be missed.



Master priority:

- **MASTER ENABLE attenuation:** sets the signal level for the master input when enabled from the terminal "MASTER ENABLE".
You can choose the activation levels between 0 dB and -18 dB

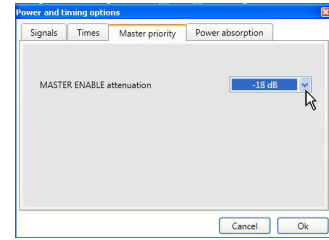

Power Absorption: By enabling this box you can limit the power absorbed by **AP4.9 bit**.

If **AP4.9 bit** is powered through pre-existing vehicle wiring, there may be a heavy voltage drop at the top of the power supply terminals on the device. This could happen because the cross-section of the pre-existing cables is too small. The voltage drops are proportional to the musical power peaks at high volumes and could generate distortions or even temporary shut down of **AP4.9 bit**. If this situation occurs, check the **"ENABLED"** box and choose the highest current value, in order to eliminate the problem previously described.

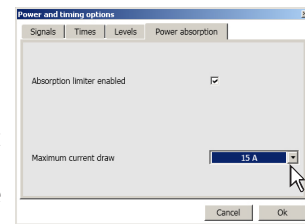

WARNING: The current limitation allows power peaks, intervening only when they are very frequent and prolonged. It temporarily reduces the maximum volume of **AP4.9 bit**.



7.3.5 DEVICE MAIN MENU **5**

By clicking on this item, a drop-down menu appears with the entries shown in the image:

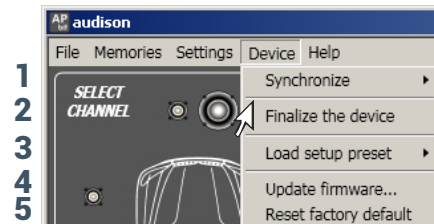

1. Synchronize: This function synchronizes the PC with **AP4.9 bit** and vice versa due to communication losses caused by the device shutting down or for other reasons.

Read from Device: The PC loads the settings present in **AP4.9 bit** memory to the PC Software.

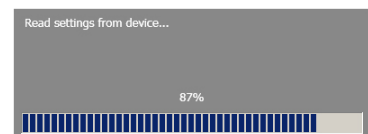

Write to device: The PC loads the current settings to **AP4.9 bit** memory.

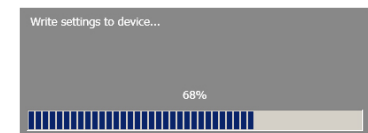

2. Finalize the device: Lets you load all of the parameters set during system calibration in the internal memory, letting the **AP4.9 bit** operate without being connected to the PC.

When Finalize to **AP4.9 bit** is performed, the software gives a warning that the previously saved data in **AP4.9 bit** will be overwritten.

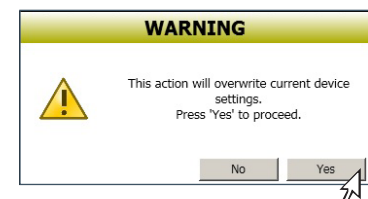

- Click on **YES** to load the data.
- Click on **NO** to interrupt the procedure.

3. Load setup preset: loads one of the 7 "PRESETS" in the **AP4.9 bit** preset 0 memory, to be editable (see sec. 5.4.2 - 5.4.8).

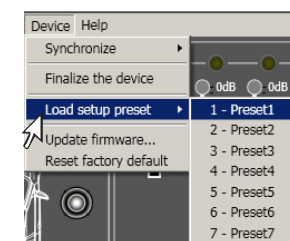

4. Update firmware: This allows firmware updates on **AP4.9 bit** (see sec. 8.3).

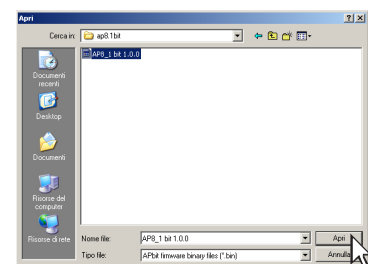

5. Reset factory default: Performs full reset of **AP4.9 bit** returning the product to its original conditions, deleting all previously saved data from the processor memory.

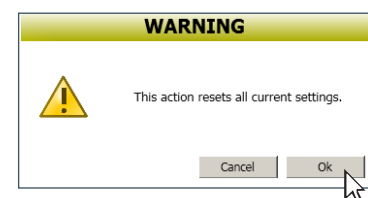

7.3.6 HELP MAIN MENU

6

By clicking on this item, a drop-down menu appears with the entries shown in the image:

- 1) **Help (online):** This function requires an internet connection. By activating this function and moving the mouse pointer to the various sections of the graphic interface for the PC software, the concerned area will be highlighted in red. By clicking on the red area, a link will activate, opening up the default browser, displaying the paragraph of the manual related to that specific area. The manual will be displayed in the language selected in FILE-> PREFERENCES (see sec. 7.3.2)

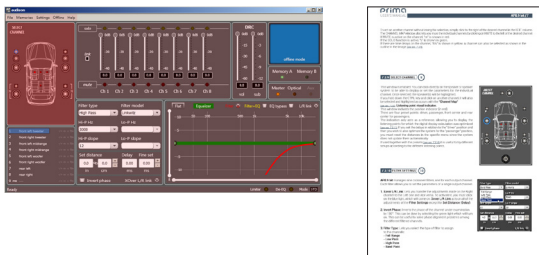

Help	
1	Help (online)
2	Tutorials (online)
3	User's manual (online)
4	Diagnostic...
5	Check for updates (online)
6	Check for updates on startup
7	Register product (online)
8	About

- 2) **Tutorials (online):** This function requires an internet connection. Clicking on this item activates a youtube link to consult audio/video information regarding the product.
- 3) **User's Manual (online):** the internet browser installed in your PC will open up and a research for the URL www.audisonbitdrive.eu will automatically start, offering the possibility to check the product manual online.
- 4) **Diagnostic:** this function is to use exclusively if requested by the Audison authorized service centre. It generates a file named "xxxxxxxxx.dng" that is saved on the PC desktop, to diagnose the product. This function is useful to fix installation issues remotely.
- 5) **Check for Updates:** Connects to the website www.audisonbitrive.eu and checks for updates to the **AP4.9 bit** Software/Firmware in order to be able to update the device in use (see sec. 8.3). To perform this operation, the PC must have an active internet connection.
- 6) **Check for Updates on startup:** when enabled the availability of new firmware/PC Software updates is checked automatically each time you start the program.
- 7) **Register product:** This function requires an internet connection and opens the default browser to the page for registering the product and creating a personal account in the "bit Drive" portal. This operation only needs to be performed once; then you can access your account through the Login Account.
- 8) **About:** Shows information regarding **AP4.9 bit** software in use.

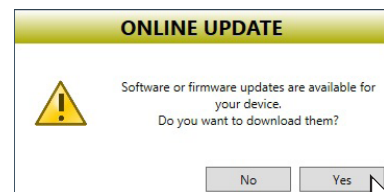

7.3.7 SELECTED INPUT

7

The "Selected Input" window shows the active source during connection with the PC. This can be used to select the desired source. Once disconnected from the PC, you can select the input source through the DRC (see sec. 9) or through the external functions "MASTER ENABLE" and "OPTICAL ENABLE".



7.3.8 CHANNEL MAP

8

This window shows the name attributed to the output channels. The window is active. You can click on it to manage the individual channel that, once selected, will be highlighted. If you hold down the CTRL key and click on another channel, it will also be selected and highlighted. At the same time, the filter curve will appear on the graph area. Multiple selection is only allowed for functional groups, except for the Subwoofer, which can be selected together with any group.

E.g.: Front Left Full together with Subwoofer, but not with Rear Left Full.

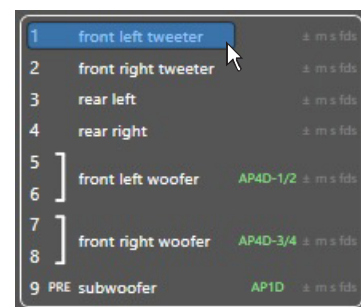

If you wish to check the electrical response of the Rear system together with the Subwoofer, you must clear the Front system selection. However, the software will only let you operate on a single channel and will show the message "EDIT" in red to the side of the channel that you can operate on. More specifically, the graph will show the electrical responses from the only crossover related to the channel being edited in red. The overall electrical response from all channels selected will be shown in yellow, taking into account the crossover filters and equalizations. The final result will be shown in green.

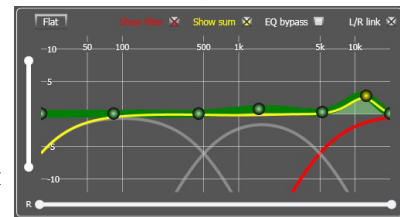

To act on another channel without losing the selection, simply click to the right of the desired channel in the EDIT column. The CHANNEL MAP window also lets you mute the individual channels by clicking on MUTE to the left of the desired channel.

If MUTE is active on the channel, "m" is shown in red.

If the SOLO function is active, "s" is shown in green.

If there are time delays on the channel, "fds" is shown in yellow. A channel can also be selected as shown in the outline in the image (see sec. 7.3.9).

7.3.9 SELECT CHANNEL 9

This window is enabled. You can click directly on the speaker or speaker system to be able to display or set the parameters for the individual channel. Once selected, the speaker(s) will be highlighted.

If you hold down the CTRL key and click on another channel, it will also be selected and highlighted as occurs with the "Channel Map"

(see sec. 7.3.8). **Listening point visual indicator.**

This window includes the position indicator (in red).

There are four preset points: driver, passenger, front center and rear center for passengers.

The indication only acts as a reference, allowing you to display the listening points for which the digital display calculation was optimized (see sec. 7.3.11). If you set the delays in relation to the "driver" position and then you wish to also optimize the system for the "passenger" position, you must reset the distances in the specific menu since the system does not update them automatically.

If used together with the presets (see sec. 7.3.14) it is useful to try different setups according to the different listening points.

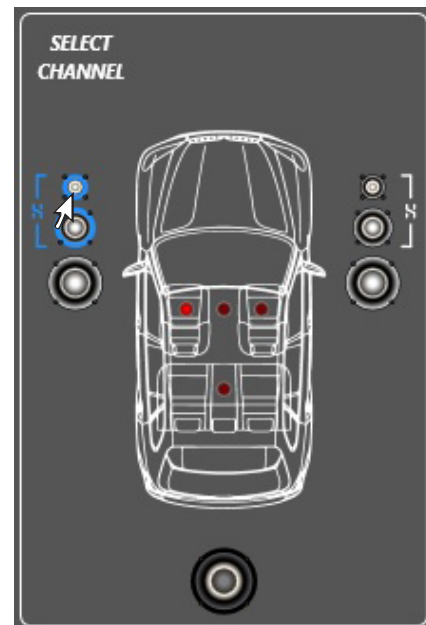

7.3.10 FILTER SETTINGS 10

AP4.9 bit manages nine crossover filters, one for each output channel. Each filter allows you to set the parameters of a single output channel.

1. Xover L/R Link: Lets you transfer the adjustments made on the Right channel to the Left one and vice versa. To activate it, you must click on the blue light, which will come on. **Xover L/R Link** acts on all of the adjustments of the **Filter Settings** except for **Set Distance (Delay)**.

2. Invert Phase: Inverts the phase of the channel under examination by 180°. This can be done by selecting the green light which will turn on. This can be useful to solve phase alignment problems among the different filtered channels.

3. Filter Type: Lets you select the type of filter to assign to the channels:

- Full Range
- Low Pass
- High Pass
- Band Pass

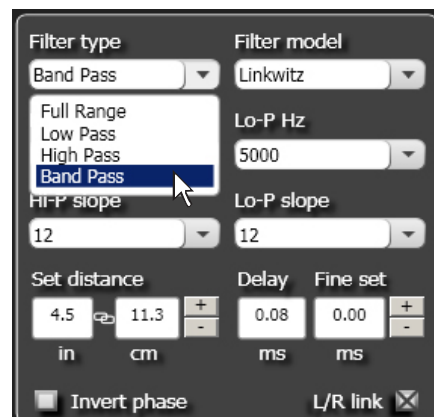

In **STANDARD** mode:

Depending on the speaker or speaker system selected during configuration, a suitable type of filter will be available.

E.g.: For the Front Woofer, only Low Pass or Band Pass will be available. For Front Mid-Hi, only High Pass and Band Pass will be available, etc.

In **EXPERT** mode:

Any speaker system selected has any type of filter available.

WARNING: In **EXPERT** mode, pay careful attention to the filter selection. Speakers have mechanical limits that must not be exceeded, otherwise it could lead to permanent damage.



When a filter is selected, some optimized cut-off frequencies are set by default to avoid breaking the speakers.

E.g.: If you select Low Pass for a tweeter, the default frequency is suitable for a woofer but not for the tweeter, which could be damaged.

STANDARD MODE

FILTER TYPE ->	Full Range	Low Pass	High Pass	Band Pass
Tweeter			X	X
Midrange				X
Woofer		X		X
Mid-Hi			X	X
Subwoofer		X		X
Full	X	X	X	X

EXPERT MODE

FILTER TYPE ->	Full Range	Low Pass	High Pass	Band Pass
Tweeter	X	X	X	X
Midrange	X	X	X	X
Woofer	X	X	X	X
Mid-Hi	X	X	X	X
Subwoofer	X	X	X	X
Full	X	X	X	X

4. Filter Model: lets you select the type of filter to be applied.

- **Linkwitz** (default)
- **Butterworth**

When launching **AP4.9 bit** software, **Linkwitz** is proposed as the filter model for the speaker or speaker group connected to the related channel. To apply the opposite (Left/Right), enable the Xover L/R Link. If you change the model to **Butterworth**, the change will be applied.

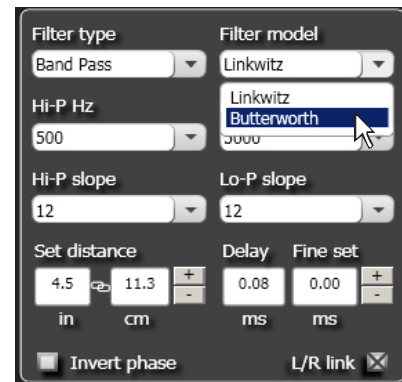

5. Cut-off frequencies

- **Hi-P Hz** 10 ÷ 20000: High-Pass filter
- **Lo-P Hz** 10 ÷ 20000: Low-Pass filter

If you select the **Band-Pass** filter, both the **Hi-P Hz** and the **Lo-P Hz** boxes will be enabled to be able to set the band frequency.

You can select the cut-off frequency by:

- clicking on the related drop-down menu, selecting the frequency range that includes the value to be set and then clicking on the actual value.
- clicking on the related drop-down menu, selecting the pre-chosen frequency range and then moving from value to value using the arrow keys (up / down) on the PC keyboard.
- clicking twice on the related drop-down menu and then moving from value to value by scrolling with the mouse.

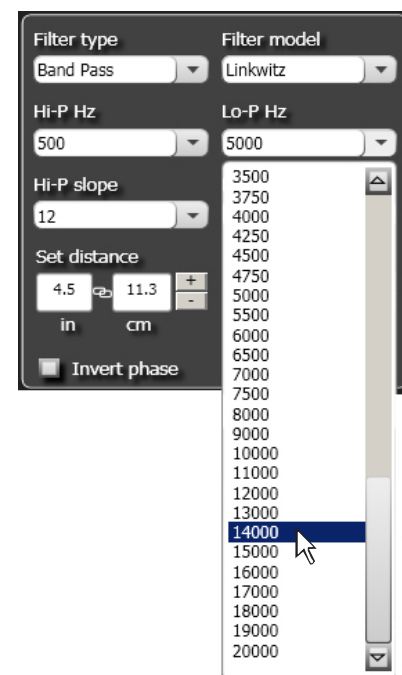

6. Filter slope

- **Hi-P Slope** 12/24 dB/Oct. (Linkwitz) 6/12/18/24dB/Oct (Butterworth)
 - **Lo-P Slope** 12/24 dB/Oct. (Linkwitz) 6/12/18/24 dB/Oct (Butterworth)
- When starting the AP4.9 bit software, it offers Linkwitz with 12 dB/Oct. slope.

E.g.: If you select Band Pass as the filter type, the same slope will be applied to both the hi-pass and low-pass as the default slope, but they can also be unbound.

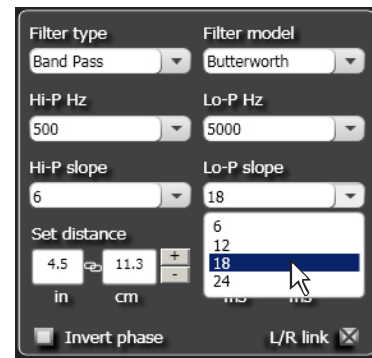

The crossover filter response related to the selected channel is displayed graphically by a yellow curve, as shown in the examples below.

E.g. Band Pass

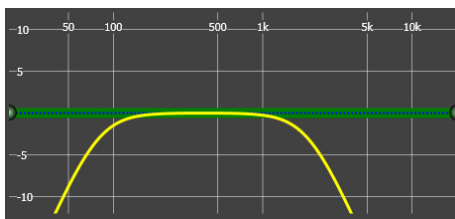

Crossover Frequency 80 - 2000 Hz @ 12 dB Oct.

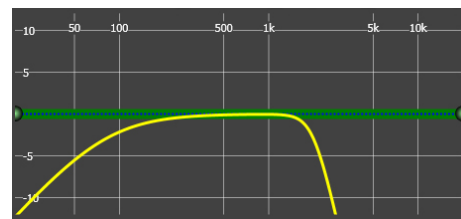

Crossover Frequency 80 Hz @ 6 dB Oct. Hi-pass
2000 Hz @ 24 dB Oct. Low-pass

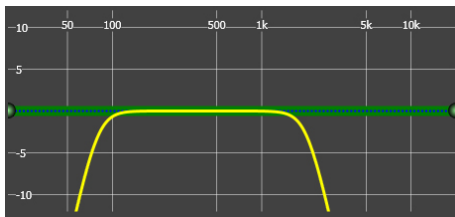

Crossover Frequency 80 - 2000 Hz @ 24 dB Oct.

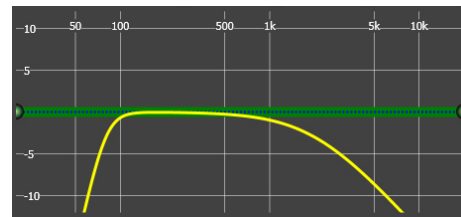

Crossover Frequency 80 Hz @ 24 dB Oct. Hi-pass
2000 Hz @ 6 dB Oct. Low-pass

7.3.11 SET DISTANCE AND DELAY

11

This setting is based on an automatic system that calculates the time needed for the sound to get from the speaker to the listener's ear.

Preliminary remarks

Sound moves through the air at a speed of 343 m/sec (1.125 ft/sec.) at a temperature of 20° C (68° F). If you know the distance from the sound emission point, you can then calculate the time the sound takes to get to the listener's ear.

If you set the distances of the different speakers, **AP4.9 bit** will automatically change them into time (ms - milliseconds). It does not assign a delay (0.0 ms) to the farthest speaker (usually the Subwoofer) and progressively growing delays as much as the other speakers get closer to the listening point, in order for all the emission points to reach the listening point at the same time.

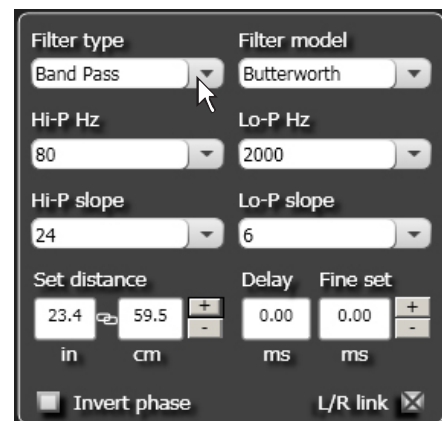

SET DISTANCE

Lets you set the distance between the speaker and the listening point. Choose cm (centimeters) or in (inches). The "Set Distance" boxes can be set using the cursors.

DELAY ms/default

Displays the time in ms (milliseconds) calculated according to the distance.

DELAY ms/fine set

AP4.9 bit time delay calculation system also lets you perform manual fine tuning.

Preliminary remarks

Fine set and Phase delay

Delay assignment according to distance calculation is theoretical.

Small variations must be applied due to small errors in distance measurement, back-wave reflections inside the car and, primarily, the speaker phase problem.

Two speakers reproducing two frequency areas that are close to each other (e.g.: Woofer and Midrange) will simultaneously reproduce the same frequencies in their crossing area, at a attenuated level. Due to the different nature of the speakers, they will have a phase difference that, for a short frequency interval, acts as a time delay. By using **"fine set"**, you can partly correct these **Phase Delay** problems.

By using the **"fine set"** button, you can change the automatically set delay time.

The delay is increased (+x.xx) or decreased (-x.xx) by the delay value shown in the window "Delay/default" and does not change the value shown, which is the one that is automatically assigned.

Assigning a positive value (+x.xx) using **"fine delay"** means increasing the delay for that speaker and thus moving it farther away from the listening point.

Likewise, assigning a negative value (-x.xx) means decreasing the speaker delay and thus moving it closer to the listening point.

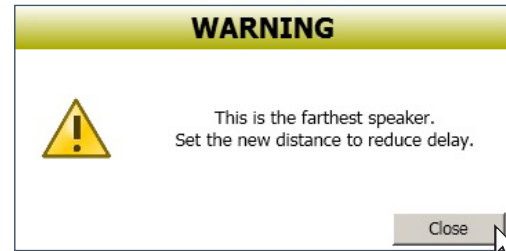

(Fig.1)

In order for you to see how much **"Fine Set"** has been manually changed, both delay values are shown. To see the resulting delay, physically applied to the output, you have to add the values shown in the **"Delay / Default"** and **"Delay / Fine Set"** boxes. A negative value (decreasing the delay) can not be assigned to the farthest speaker; it can only be assigned to the other speakers as they are all already delayed compared to the farthest one. If you attempt to give the farthest speaker a negative value, a warning message will appear (Fig. 1).

When using **"fine set"** "fds" will appear in green on the corresponding channel on the **"Channel Map"** (Fig. 2)

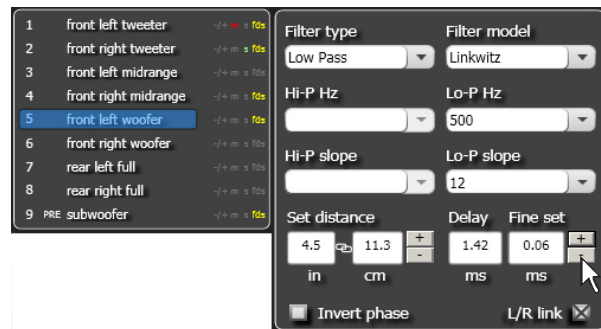

(Fig.2)

Example of setting the time delay (Fig. 3):

1. Choose the system listening point.
To identify the listening point, choose an ideal spot in the center of the listener's head (driver or passenger).
For the front center and rear center, choose a point between the two listeners.
2. Measure the distance in a straight line from each speaker or group of speakers compared to the listening point. For each speaker, choose the center of the mobile membrane as the emission point.
For groups of speakers, choose a point between them. It will then be possible to fine tune it using the Fine Set function.
3. On the Channel Map, select the channel related to the speaker under examination and enter the respective distance in the Set Distance box in the Filter Settings menu.
4. Repeat step 3 for each channel.

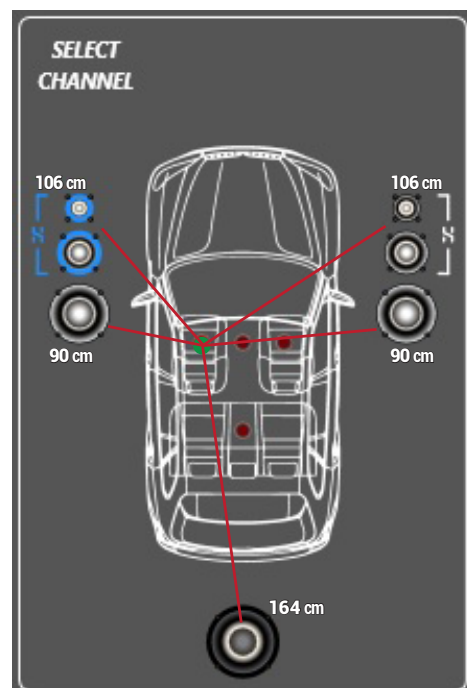

(Fig.3)

5. Once the time delay settings are complete, start the musical reproduction and use the Fine Set box, moving the values up or down (except for the subwoofer since it is the farthest speaker) to fine tune the system for optimal sound. We recommend listening to various types of music (percussion, melodic, etc.) for better evaluation of the coherence (spatial stability) of the different musical instruments.
6. Once the time alignment procedure is complete, you can work on the output equalizer (see sec. 7.3.12) to optimize the system response based on the level alignment of the various frequencies.

Remark: Measurements for the above operations can also be taken using a spectrum analyzer with a suitable microphone. The results must be evaluated and optimized through listening tests.

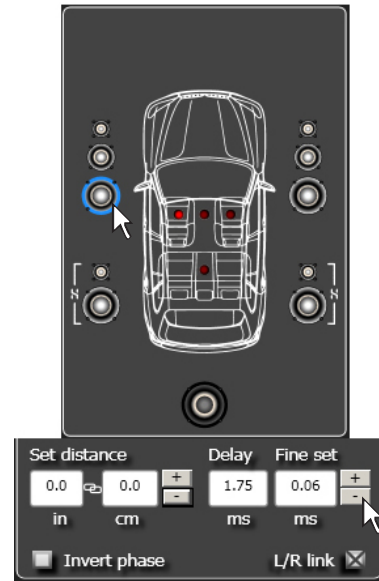

WARNING: If, once you have set the distances for the “driver” listening point, you click on the “passenger” listening point, **AP4.9 bit** won't re-calculate the delays for the new reference point because the buttons available in the **SELECT CHANNEL** diagram are merely descriptive. Their only purpose is to remind you that you have set the delays for that listening point!

7.3.12 PARAMETRIC EQUALIZER 12

The AP4.9 bit software provides an equalizer, that can be managed from a maximum of 10 graphic control points which automatically place a maximum of 10 parametric equalization points. The quantity of graphic control points used doesn't match the parametric poles quantity, which is determined by the adapting software.

The equalizer works according to the functional groups and so we have the following factory configuration:

- one equalizer for the **Front Tweeter**.
- one equalizer for the **Front Mid**
- one equalizer for the **Front Woofer**.
- one equalizer for the **Rear**.



To be able to change the parameters for the equalizer in order to set an equalization curve, just choose the channel to equalize from the "Channel Map" menu, positioning the mouse over the point to be set, and shape the curve using the left mouse button (green curve), or with the arrow keys "← → ↑ ↓" on the PC keyboard.

Remark: to select the frequency parametric pole in FINE mode, use the PC keyboard keys "CTRL + →" or "CTRL + ←".

In order to vary the "Q" factor of the equalization point selected, just scroll using the mouse wheel featuring this function or using the keys "⊕" and "⊖" on the PC keyboard.

In order to delete the changes, just put the mouse over the point, select it with the left button and press CANC on the PC keyboard.

The equalizer has specific functions that aid in calibration and make it easier.

- 1 **Flat** brings all the cursors back to the 0 dB position;
- 2 **L/R Link**, when active, applies the equalization curve to both the right and left channel simultaneously.
- 3 **EQ by Pass**, when active, lets you disable the equalizer to check its effect without losing its settings.
- 4 **Filter** lets you display the electrical response subject to filtering (XOVER), by clicking on the box (red curve).
- 5 **Filter + Eq** lets you display the electrical response subject to equalization, by clicking on the box (yellow curve).

Remark: In order to clearly display the set equalization curve, you can increase or decrease the vertical axis (dB) and horizontal axis (Hz) by moving the cursors to the side of them. The default is set to +12 dB and 0-20 kHz.

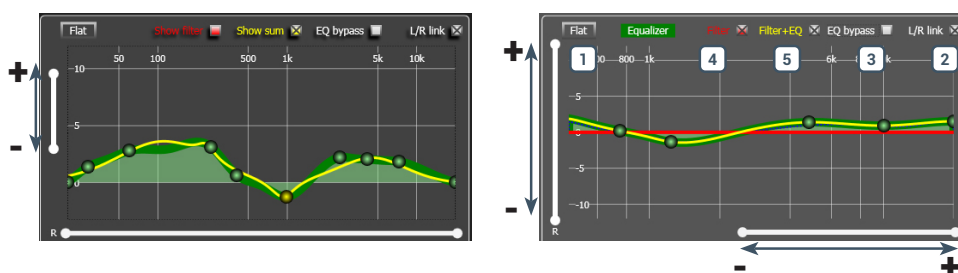

7.3.13 OUTPUT LEVEL 13

This section shows the settings related to the output levels of **AP4.9 bit** channels. The description of the points shown in the figure is given below.

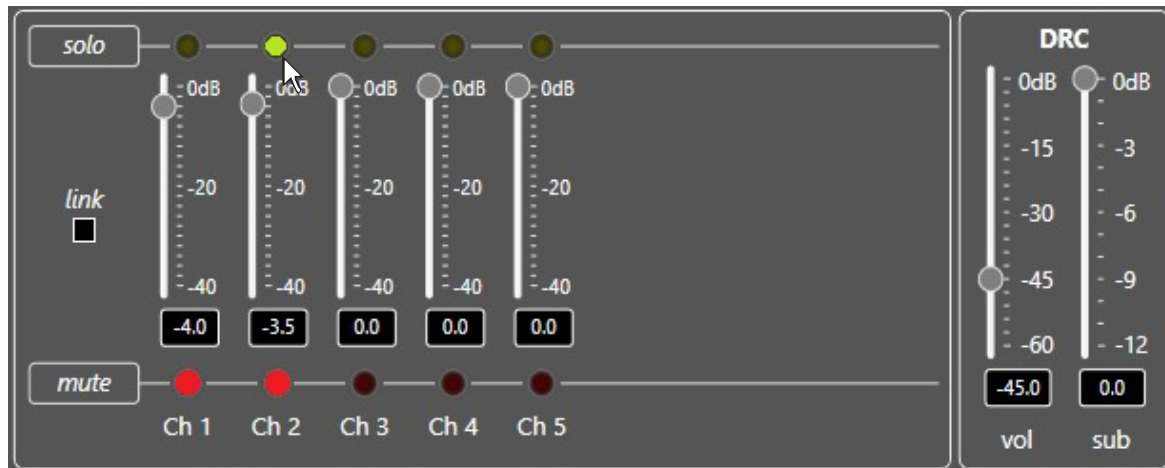

1. Using one of the sliders for the output channels, you can adjust the output level (-40÷0 dB) for each channel. The sliders are enabled based on the output configuration.
2. This part of the display shows the output level for each individual channel (-40÷0 dB), referring to the position of the Slider for the output channels.
3. By clicking on the "Mute" button you can mute the corresponding output channels.
4. By clicking on the "Mute" button again, the mute function will be disabled.
5. By clicking on the "Link" button you can simultaneously adjust all of **AP4.9 bit** output levels. By clicking on the "Link" button again, the function will be disabled.
6. By clicking on the "Solo" button you can mute the output channels except for the one enabled.
7. By manually clicking on the "Solo" button, the function will be disabled.
8. Using the "Volume" slider you can adjust the general output level for the system (-60÷0 dB).
9. Using the "Sub Volume" button you can adjust the output level of the subwoofer (-12÷0 dB), if the system features a subwoofer.

7.3.14 MEMORY 14

AP4.9 bit controls the system configuration, operating by default on memory **A** but gives the option to store and recall two memories (**A, B**).



7.3.15 STATUS BAR 15

It is an information area that can be found at the bottom of the PC software window. It shows in real time the working status of **AP4.9 bit** PC software.



- 1 Indicates the working status of **AP4.9 bit** PC software.
- 2 Indicates the setup file that has been possibly loaded via PC software to the **AP4.9 bit**.
- 3 **Bass-Boost**: When the LED is lit, that means the Bass-Boost is in operation [see sec. 7.3.4.2](#).
- 4 **De-eq**: When the LED is lit, that means the de-equalization curve of the source is enabled [see sec. 7.3.4.3](#).
- 5 **Mode**: indicates whether it is in Expert (EXP) or Standard (STD) mode [see sec. 7.3.4.4](#).
- 6 **Sensitivity**: function to recall the analog Master inputs calibration, in order to refine/adjust the sensitivity. Use a music track and adjust the sensitivity until you see the LEDs starting to flash. It is possible to intervene on every single input channel or select all input channels through the **LINK** function.

Remark: do not overdo the sensitivity adjustment. Increasing the distortion may turn on the clipping lights and worsen the signal-to-noise ratio (background noise) of your audio system.

8. TROUBLESHOOTING

8.1 SYNCHRONIZATION WITH A PC

1. AP4.9 bit operating problems

If, when calibrating the system with **AP4.9 bit** connected to a laptop there are operating problems, try disconnecting the laptop power supply cable.

With the laptop working on battery power you avoid a possible voltage difference in the USB ground between the vehicle (**AP4.9 bit**) and the ground (PC).

2. Connection lost between AP4.9 bit and the PC

If, while calibrating the system with the PC connected to **AP4.9 bit**, the amplifier is turned off and back on again, the connection is lost and the software cannot finalize the adjustments that were set. To avoid losing the settings, proceed as follows:

- a. Save the setup to a file on the PC using the **FILE / SAVE SETUP** function.
- b. Exit the software.
- c. Turn **AP4.9 bit** on.
- d. Launch the software again.
- e. Load the setup file again that was saved using the **FILE / LOAD SETUP** function.

3. AP4.9 bit does not respond

If calibrating the system with the PC connected to **AP4.9 bit** and the latter does not respond to the commands, proceed as follows:

- a. Turn off **AP4.9 bit** by pressing the knob on the DRC or disconnecting the Remote IN or even disconnecting the power cable for a second.
- b. Save the setup to a file on the PC using the **FILE / SAVE SETUP** function.
- c. Exit the software.
- d. Turn **AP4.9 bit** on.
- e. Launch the software again.
- f. Load the setup file again that was saved using the **FILE / LOAD SETUP** function.

4. Settings not saved

To successfully complete **AP4.9 bit** configuration and not lose the work done, remember to store the settings that were made. Access the **"File"** menu from the management software via the PC and choose **"Finalize the device"**.

8.2 BACKGROUND NOISE

Loud hissing/background noise.

If there is excessive hissing/background noise, it may be necessary to repeat the setup for the input sensitivity and/or correct the output level calibration. For more details [see sec. 7.2](#).

8.3 FIRMWARE UPGRADE

If there are product UPGRADES available online, proceed as follows:

- Save the previous setup (if you wish to consult it in OFFLINE mode);
- Disconnect the "Speaker out" and "Sub out" **AP4.9 bit** on.
- Disconnect the AP4.9 bit power supply positive pole or remove the fuse for 5 seconds.
- Set the product upgrade switch to the **"ON" position**
- Reconnect the power supply positive pole or restore the fuse, previously removed.
- The logo on the product begins flashing.
Start **AP4.9 bit** PC Software and select **TARGET** mode.

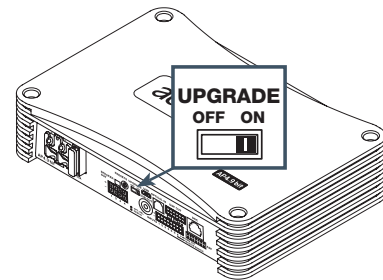

1. Access the **"Help"** menu in the PC management software and choose **"Check for Updates"**.
2. When you select **"Check for Updates"**, the internet browser in the PC will open up and will automatically search for the URL: www.audisonbitdrive.eu.

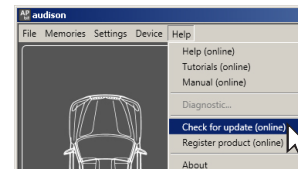

WARNING: the files must be manually downloaded from the website.
The software access method may be different from the following.
Refer to the instructions on the website.



3. Once the related page is open, click on the LINK for the product.
4. Identify the newest file whose name includes the word Firmware followed by four numbers and click on the specific symbol to start the download.
When requested, save the file to the PC.
5. Select "Update Firmware". The program will ask you to select the file that was just saved from the Download Area or that was previously saved in the PC.

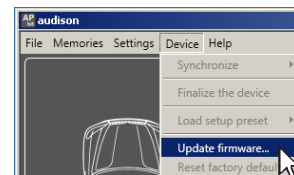

WARNING: AP4.9 bit Firmware update procedure may be tricky. It is of the utmost importance that it is done under the best possible conditions. If the operation is started and prematurely interrupted (e.g.: PC locked up, loss of power to **AP4.9 bit**, accidental disconnection of the USB cable during update), you might need to contact our Customer Service for further support as **AP4.9 bit** may need to be reprogrammed".



6. Before starting **AP4.9 bit** update, the program warns you to:
 - not disconnect **AP4.9 bit** from the PC;
 - not disconnect **AP4.9 bit** from power;
 - temporarily disable the PC automatic stand-by processes;
 - temporarily disable the screen saver on the PC;
 - close all running applications;
 - temporarily disable the anti-virus and anti-spyware systems.
7. Once you have clicked on **OK**, the Firmware update procedure starts.
This process will last between 30 seconds and 1 minute; the progress bar and the flashing logo on the **AP4.9 bit** will show its the updating process status.

WARNING: during the update, the updating process of the progress bar may stop for a few seconds. Do not interrupt the process in any way.

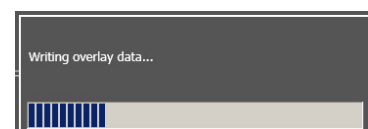

8. When successfully completed, a notification window will appear. In order to be able to use **AP4.9 bit** again, you must close the program on the PC and turn off **AP4.9 bit**.
9. Disconnect the AP4.9 bit power supply positive pole or remove the fuse for 5 seconds.
10. Set the "UPGRADE" switch to the OFF position.
11. Reconnect the power supply positive pole or restore the fuse, previously removed.
12. Turn **AP4.9 bit** back on and restart the PC software. If **AP4.9 bit** firmware update completed correctly, the dialogue window will show:
 - new **AP4.9 bit** Firmware version.
13. Repeat the product calibration operations ([see sec. 7.2](#)).

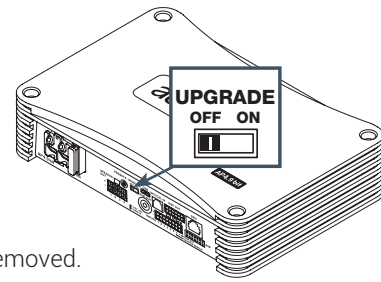

9. DRC - DIGITAL REMOTE CONTROL (OPTIONAL)

The DRC is **AP4.9 bit** remote control system. It is a microprocessor digital system that can also remotely control and monitor any amplifiers equipped with the AC Link bus control.

When first turned on, the display will show the Firmware version installed on the DRC.

When configuring **AP4.9 bit** using the PC, the DRC may stay connected but will show the message "PC control - DRC is disabled" on the display.

Its functions are as follows:

- **AP4.9 bit** power on / off;
- Main volume control;
- Subwoofer volume control;
- Front/Rear Fader control;
- Connected sources selection;
- Memory selection.

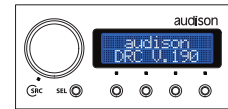

DRC CONTROL DA PC

AP4.9 bit ON
Press Shorly

AP4.9 bit OFF
Press for 2 seconds

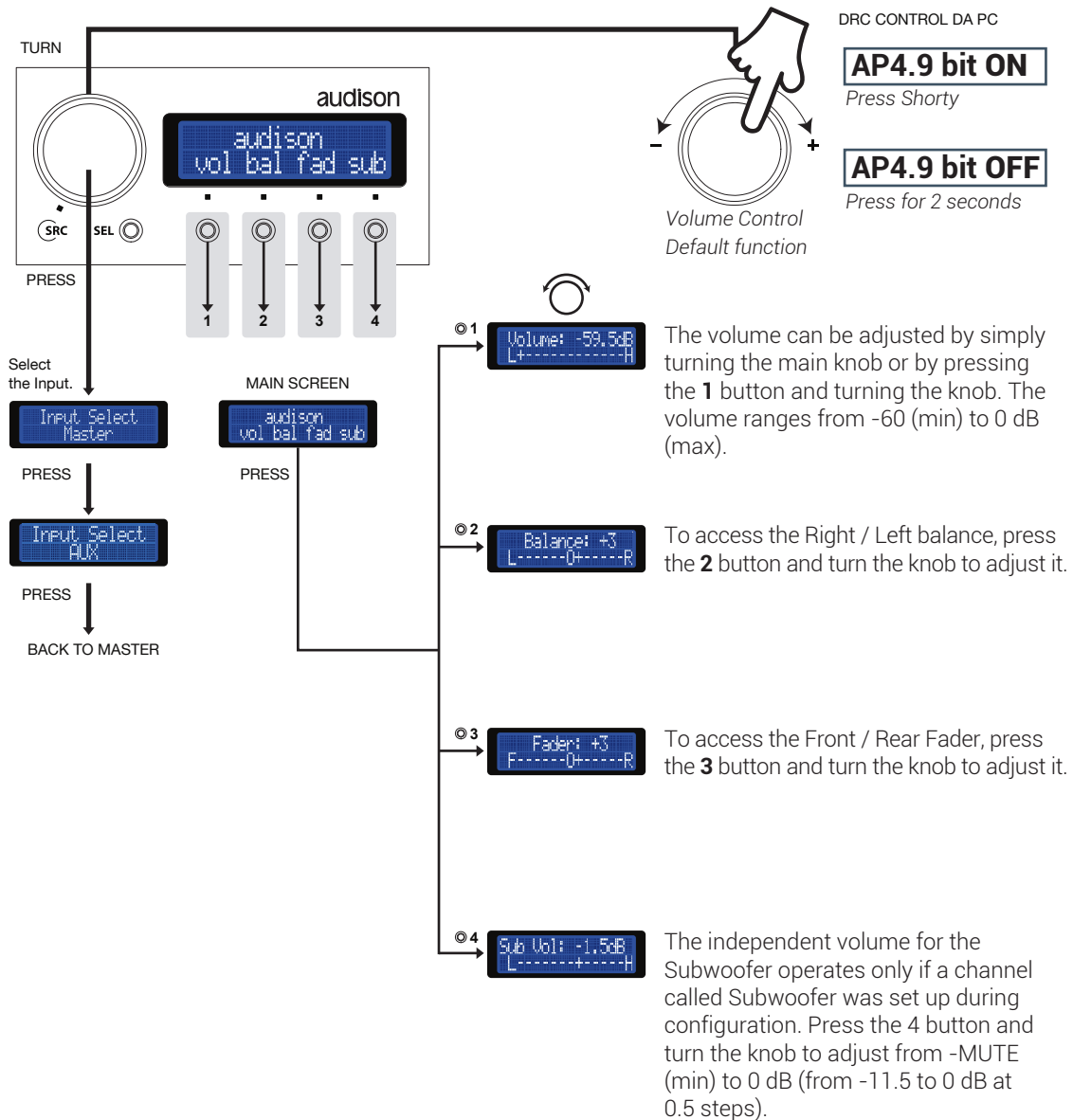

9.1 SEL BUTTON FUNCTIONS

By pressing the SEL button you can access:

- **DSP Memory:** you can directly recall the A/B memories (saved through the software) and load them in **AP4.9 bit**.
- **bass boost en:** by clicking on "Y", it enables the "Bass Boost" function. By clicking on "N", it disables the "Bass Boost" function (see sec. 7.3.4.2).
- **Brightness:** to adapt the DRC to the light conditions inside the car, you can adjust the brightness of the display and the red ring on the buttons.

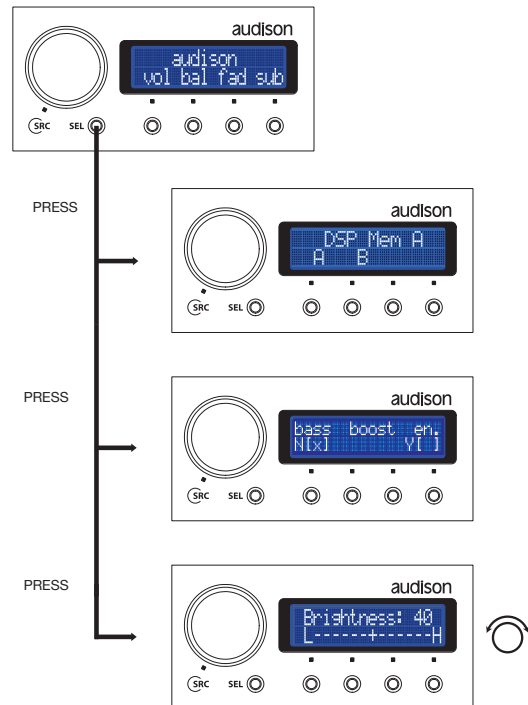

9.2 OPERATIONAL ERROR MESSAGES



It indicates activation of the amplifier thermal protection as temperature reached 80 degrees Celsius. The amplifier will get back to normal functioning when temperature decreases to 75 degrees Celsius.



It indicates activation of the amplifier thermal protection due to overloaded outputs.



It indicates activation of amplifier thermal protection due to battery voltage exceeding 16 VDC.



It indicates an internal fault. You should contact an authorized Audison service centre.

10. ACCESSORIES

10.1 ASP - AUTOMATIC SPEAKER PRESENCE

ASP is indispensable when installing **AP4.9 bit** with some OEM sources requiring, only at the initial turn-on instant, a resistive load impedance at the outputs to detect the speakers' presence.

In case there is no load, the source disables the outputs, usually only for the Rear section.

Therefore, if during the calibration process you cannot adjust the input signal level due to lack of signal on some or all of the **AP4.9 bit** inputs, while installing the **ASP** module, when you turn on the **AP4.9 bit** a temporary load will be simulated; afterwards that load will automatically get disabled, fixing the issue.

Thanks to **ASP**, there is no need to mount fixed power resistors at the source outputs; the resistors would produce heat and, in addition to that, would make the source heat up unnecessarily.



10.2 ACP 2 - 2 RCA ADAPTER CABLE

It is a kit made up of wiring **INPUTS AP4.9 bit** with RCA connectors for the IN1 and IN2 inputs and a 3.5 mm RCA/Jack adapter.

This wiring manages the signals coming from pre-amplified auxiliary sources (AUX) **through the RCA inputs or portable auxiliary sources using the 3.5 mm RCA/Jack adapter.**



10.3 ACP 6 - 6 RCA ADAPTER CABLE

It is a kit made up of wiring **INPUTS AP4.9 bit** with RCA terminations for the FL,FR,RL,RR,IN1 and IN2 inputs and a 3.5 mm RCA/Jack adapter.

This wiring manages the signals coming from pre-amplified auxiliary sources through the RCA inputs or portable auxiliary sources on the IN1 and IN2 inputs. Portable audio sources can be connected using the 3.5 mm RCA/Jack adapter.



10.4 APL 2 - (AP4 D / AP1 D) LINK CABLE

Cable to connect AP4.9 bit and AP4.9 bit to AP4 D and AP1 D amplifiers ([see section 4.7.3](#)).

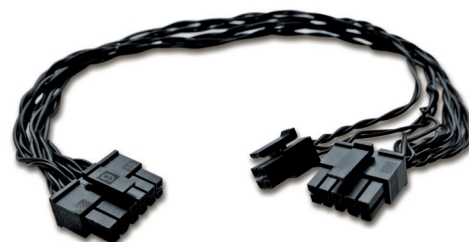

10.5 APTK 3 - AUDISON PRIMA TOWER KIT 3

With the APTK 3 (Audison Prima Tower Kit 3) installation system, up to 3 AP amplifiers can be stacked in order to save space without them overheating.

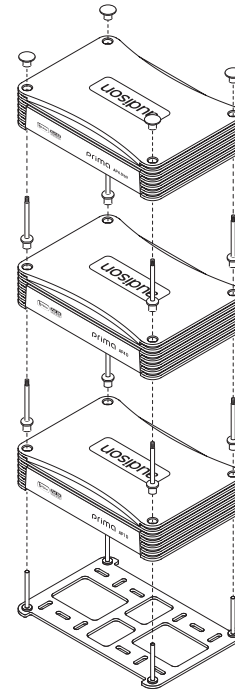

10.6 DRC DIGITAL REMOTE CONTROL

The DRC is the digital interface between the bit processors and the user.

The DRC mounted on the vehicle dashboard with the **AP4.9 bit** processor offers:

- The ability to select between main and aux inputs
- Control of the general volume, subwoofer volume, balance and fader.
- The ability to choose between 2 memory presets defined by the user for the alignment settings of the equalizer, crossover and time.



10.7 ECK DRC-CABLE EXTENSION KIT

This kit includes a cable and an adapter that lets you extend the length of the cable provided with the DRC by 2 m. This extension cable is needed for installations in very long vehicles like large SUVs. The total length of the standard cable and extension combined is 6.5 m.



10.8 OP 1.5 TOSLINK OPTICAL CABLE 1,5 M / 59.05 IN.

Optical cable with TOSLINK connectors for S/PDIF digital audio signals.

Cable length 1.5 m / 59.05 in.



10.9 OP 4.5 TOSLINK OPTICAL CABLE 4,5 M / 177.16 IN.

Optical cable with TOSLINK terminations for S/PDIF digital audio signals.

Cable length 4.5 m / 177.16 in.



10.10 STA - F/F SOCKET TOSLINK ADAPTER

Optical adapter to extend optical cables with TOSLINK connectors.



10.11 SFC - SAMPLING FREQUENCY CONVERTER

SFC is a digital audio signal adaptor (SVPDIF) to place between two devices with digital input/output. The main purpose of this adaptor is to solve issues related to digital interfacing of the two devices such as:

1. Digital head unit with higher sampling frequency (96/192 kHz) while the receiver can't handle frequencies higher than 96 kHz.
2. The receiver/transmitter does not feature an optical or electric coaxial input/output: the SFC can be used to recreate the missing connection.
3. Malfunctioning or anomalous noises when the head unit is set to "Pause". The issue is caused by the fact that while being paused some head units strip away the digital signal carrier wave; SFC constantly provides the carrier wave to the receiver.
4. When "Play" is selected on the head unit and the music program is started or during normal functioning intermittent noises can be heard even at low volume. This phenomenon is due to poor quality or insufficient level of the digital signal; SFC can recover the signal eliminating the issue.



Description

SFC is a sampling frequency converter; it converts the digital signal, inputting an S/PDIF digital signal with from 32 kHz to 192 kHz sampling frequency and outputting an S/PDIF digital signal with 48 kHz sampling frequency.

SFC does not alter the information travelling along the signal, it can not handle AC3® or Dolby Surround® encoded signals but just stereo PCM ones and does not convert the digital signal into analog.

SFC features two inputs: one coaxial electrical (75 Ω) and another optical (TOSLINK). You have to select which input will be used through the INPUT MODE switch.

When the ERROR LED lights up, it indicates either that the input signal is not stereo PCM or that the signal is instable; in that case, the SFC goes into "Mute" status not to damage the devices connected to its outputs.

SFC features two outputs: one coaxial electrical (75 Ω) and another optical (TOSLINK). Both the outputs are active.

11. TECHNICAL SPECIFICATIONS

POWER SUPPLY	
Voltage:	7.5 ÷ 15 VDC
Idling current:	1.32 A
Switched off:	<2 mA
Consumption @ 14.4 VDC 2Ω Max Musical Power (without CLP):	30 A
Remote IN	7 ÷ 15 VDC (1 mA)
Remote OUT	11 ÷ 15 VDC (200 mA)
Fuse	30 A
ART (Automatic Remote Turn on/off)	Speakers to input - selectable
AST (Automatic Signal Turn on/off)	Pre-In to input - selectable
CPL (Continuous Power Limiting)	Max continuous power - selectable
AMPLIFIER STAGE	
Distortion - THD @ 1kHz 4Ω, 90% Output Power:	0.10 %
Bandwidth @ -3 dB, 2 V RMS, 4Ω:	10 ÷ 20 kHz
S/N ratio @ A weighted, 2V, Output Power:	95 dB A
Damping factor @ 1 kHz, 2 V RMS, 4Ω:	>170
Input sensitivity:	2 ÷ 15 V RMS
Input impedance:	15 kΩ
LOAD IMPEDANCE (MIN):	
• 4 Ch: 1-2-3-4	2 Ω
• 2 Ch - Bridge (1-2) (3-4)	4 Ω
MAX POWER:	520 W
OUTPUT POWER (RMS) @ 14.4 VDC, 1% THD:	
• 4 Ch @ 4Ω:	70 W x 4
• 4 Ch @ 2Ω:	130 W x 4
• 2 Ch - (Bridge 1/2; 3/4) @ 4Ω:	260 W x 2
OUTPUT POWER (RMS) @ 14.4 VDC, 10% THD:	
• 4 Ch @ 4Ω:	90 W x 4
• 4 Ch @ 2Ω:	180 W x 4
• 2 Ch - (Bridge 1/2; 3/4) @ 4Ω:	360 W x 2
CEA Specifications:	
• Output power @ 4 Ω, ≤ 1% THD+N, 14.4 V	70 W x 4
• SN ratio (ref. 1 W output)	75 dB A
SIGNAL CONNECTIONS	
Input Stage:	
• Config 1	Hi / Lo level FL-FR-RL-RR + N.2 customizable
• Config 2	Hi / Lo level FL-FR-RL-RR + Stereo Aux In (Selectable: DRC/wire)
• Optical IN (S/P-DIF PCM)	96 kHz/24 bit max (Selectable: DRC/wire)
DIGITAL SIGNAL PROCESSOR (32 bit Cirrus Logic; Clock speed: 147 MHz)	
Crossover:	Full / Hi-Pass / Lo-Pass / Band Pass
Crossover type and slope:	Linkwitz @ 12/24 dB - Butterworth @ 6/12/18/24 dB
Crossover Frequency:	68 steps @ 20 ÷ 20k Hz
Phase inversion:	0° / 180°
Analog Input Equalizer:	Automatic De-Equalization
Output Equalizer	N.9 Parametrics Equalizers: ±12 dB;10 pole; 20 ÷ 20k Hz
Time Alignment Distance	0 ÷ 510 cm / 0 ÷ 200.8 in.
Time Alignment Delay	0 ÷ 15 ms
Time Alignment Step	0,08 ms; 2,8 cm / 1.1 in.
Time Alignment Fine Set	0,02 ms; 0,7 cm / 0.27 in.
SYSTEM SET:	
Preset (Drive Preset)	Rotary switch for 7 installation Presets
Acoustic Preset	N.2 DSP Memory, DRC selectable/customizable
CONTROL CONNECTIONS	
From / to personal computer	1 x micro USB-B
To Audison Electronics	DRC controls
ASP Connector	For module: Automatic Speaker Presence (ASP)
Optical / AUX select	12V control for Optical In / AUX enable
Master enable	12V control for Master In enable
GENERAL REQUIREMENTS	
PC connections	Micro USB (1.1 / 2.0 / 3.0)
Software/PC requirements:	Microsoft Windows (32/64 bit): XP, Vista, Windows 7, Windows 8
Graphic card min. resolution:	800 x 600
Ambient operating temperature range:	0 °C to 55 °C (32°F to 131°F)
SIZE / WEIGHT	
Max size (mm/in.):	198 x 45,50 x 134 / 7.8 x 1.8 x 5.27
Weight (kg/lb):	1,36 / 2.99

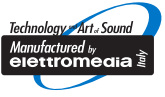

audison.com

audison
ISTINTO
INNOVATIVO

PART OF ELETTRONEDIA
62018 Potenza Picena (MC) Italy
T +39 0733 870 870 - F +39 0733 870 880
www.elettromedia.it